

OWNER'S MANUAL

FOR MODELS:

620 Kitchenaire

Spiral plates

621 Kitchenaire

Solid plates

CONTENTS

- 2 Introduction
- 2 Unpacking
- 2 Installation
- 2 Electrical installation
- 2 Connecting the sprauge to the stove
- 3 Anti-tilt mechanism
- 4 Safety advice
- 5 Control panel
- 5 6 Position selector knob
- 6 Using the oven
- 7 Solid plates
- 8 Spiral plates
- 8 Warming drawer
- 8 Maintenance
- 9 Cleaning the oven
- 9 Replacing the oven lamp
- 9 Removable oven door
- 10 Do and Don't guide
- 11 Problem check
- 11 Owners responsibility
- 11 Branches
- 12 Warranty
- 12 Purchase details

Part Number 069179



Believe in better

Kitchenaire Stove

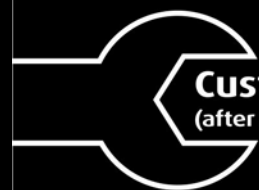

Customer Care Line
(after sales service)

086 100 3339



The Manufacturer strives for continuous improvements. For this reason, the text and illustrations in this book are subject to change without notice.

Please register your product at
www.defy.co.za

Introduction

Congratulations on the purchase of this quality product.

We trust that you will enjoy many years of trouble free use. Please read these instructions carefully before using the stove. This manual will provide you with information on how to operate and care for your product in order that you gain the maximum benefit from it.

Unpacking

- Please ensure that packaging material is disposed of in a responsible manner.
- Plastic bags should be cut up to prevent children playing with them and accidentally suffocating.
- Remove all packing from the oven cavity and position the accessories.
- If the appliance is damaged in any way, do not use it. Report the damage to your dealer, who will take the necessary corrective action.

Installation

- Levelling feet are provided to assist you in positioning your stove, so that it will stand firm and level. To adjust the level, turn the relevant foot to either raise or lower the stove.
- Surfaces immediately adjacent to the oven should be able to withstand temperatures of up to 100°C without delaminating or discolouring.

Electrical installation

This appliance must be earthed and the manufacturer and the seller do not accept responsibility for any damage due to incorrect installation or electrical connection.

This appliance should not be connected through an earth leakage system. Refer to S.A.N.S. 10142

Connection to the power supply

This appliance has a 'Y' type supply cord connection and must be installed by a licensed electrician, who will ensure that the stove is correctly connected and safely earthed. The rated current is printed on the serial number label attached to the stove upper back panel.

The appliance must be connected to the mains through an All pole isolating switch which has a minimum clearance between the contacts of 3 mm in All poles. A means for disconnection must be provided in the fixed wiring.

Connecting the sprague to the oven

- 1.) Purchase a standard plastic/metal saddle type bracket, capable of going around the 20 mm diameter sprague and with a hole pitch of 38 mm (Plastic) 45 mm (Metal), from your local hardware and 2 off 4.2 mm x 12 mm self tapping screws.
- 2.) Feed the cables through the Sprague and connect to the mains terminal block of the appliance.
- 3.) Place the plastic/metal saddle around the sprague and fasten via the 2 self tapping screws onto the factory pre punched holes adjacent to the mains terminal block of the appliance.

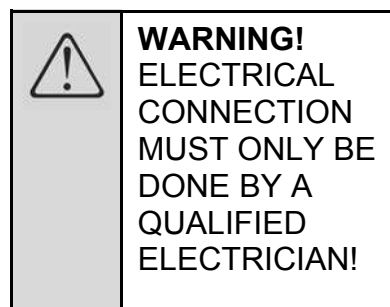
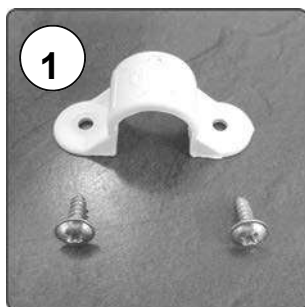

WARNING

Anti-tilt mechanism

All stoves can tilt if you or a child sit or lean on an open oven door.

Safety regulations stipulate that the ANTI-TILT mechanism supplied with the stove, must be fitted as shown below.

- “A” 1 x Stability chain
- “B” 1 x Stability hook with anchor sleeve
- “A” is factory fitted at the rear of the stove in the centre. (See overleaf for instructions if the removable splashback is to be fitted)
- Position the stove and move “A” to touch the wall behind the stove.
- Mark the hole where “A” touches the wall behind the stove.
- Move the stove away from the wall to allow for an area to work in.
- Using a 8.0 mm concrete bit, drill a hole at the marked position.
- Using the Stability hook and anchor sleeve “B”, firmly secure “B” to the wall.
- Slide the stove back in position and engage the stability chain “A” onto the Stability hook “B”.
- The stove is then secured and will not accidentally tilt if downward pressure is applied to the open oven door.



Safety regulations stipulate that the ANTI-TILT mechanism supplied with the stove, must be fitted as shown.

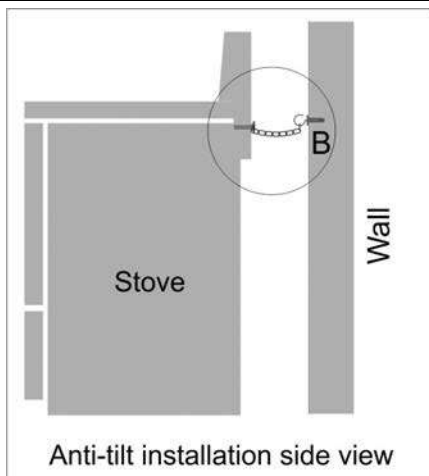

Anti-tilt installation side view

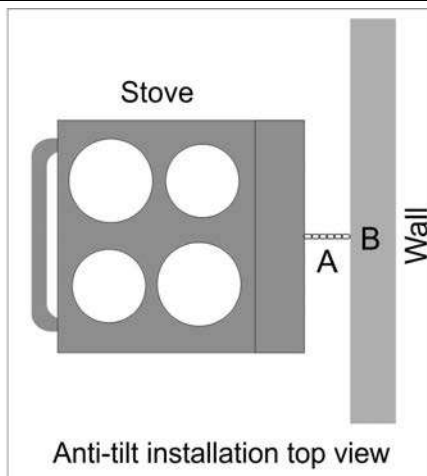

Anti-tilt installation top view

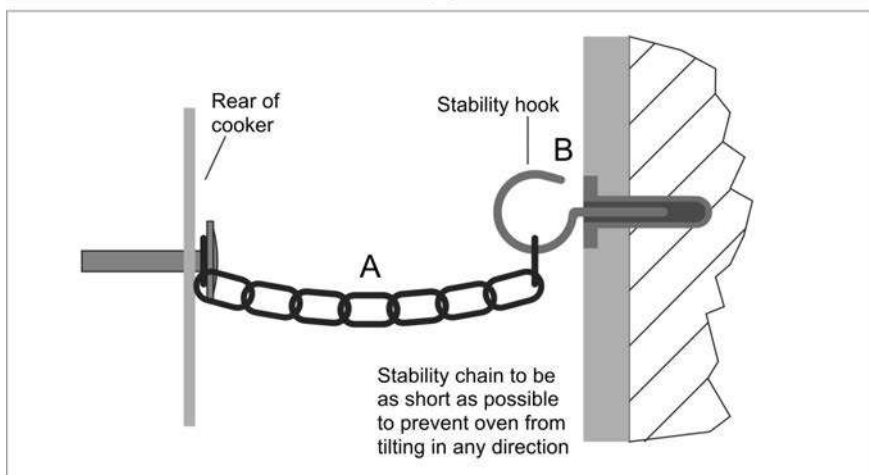

Safety advice

This section contains safety instructions that will help you avoid risk of injury and damage. All warranties will become void if you do not follow these instructions.

General safety

- **This appliance is not intended for use by persons (including children) with reduced physical, sensory or mental capabilities, or lack of experience and knowledge, unless they have been given supervision or instruction concerning the use of the appliance by a person responsible for their safety.**
- **Children should be supervised to ensure that they do not play with the appliance.**
- Connect the appliance to an earthed outlet/line protected by a fuse of suitable capacity. Have the earth installation made by a qualified electrician. Our company shall not be liable for any problems arising due to the appliance not being earthed in accordance with the local regulations.
- If the supply cord is damaged, it must be replaced by the manufacturer, its service agent or similar qualified persons in order to avoid a hazard.
- Do not operate the appliance if it is defective or has any visible damage.
- Do not carry out any repairs or modifications on the appliance.
- Never wash down the appliance with water! There is the risk of electric shock!
- Never use the appliance when your judgment or coordination is impaired by the use of alcohol and/or drugs.
- The appliance must be disconnected from the mains during installation, maintenance, cleaning and repair procedures.
- Be careful when using alcoholic drinks in your dishes. Alcohol evaporates at high temperatures and may cause a fire since it can ignite when it comes into contact with hot surfaces.
- Do not heat closed tins and glass jars in the oven. The pressure that would build up in the tin/jar may cause it to burst.
- Do not place baking trays, dishes or aluminium foil directly onto the bottom of the oven. The heat accumulation might damage the bottom of the oven.
- Keep all ventilation slots clear of obstructions.
- The appliance may be hot when it is in use. Never touch the hot burners, inner sections of the oven, heaters etc.
- Always use heat resistant oven gloves when putting in or removing dishes from the hot oven.
- Do not use the appliance with the front door glass removed or cracked.
- The rear surface of the oven gets hot when it is in use. Make sure that the gas/electrical connection does not come into contact with the rear surface as connections may get damaged.
- Do not trap the mains cable between the oven door and frame and do not route it over hot surfaces as the cable insulation may melt and cause a fire as a result of a short circuit.
- Make sure that the function knobs are switched off after every use.
- When using Gas, ensure that the room is well ventilated.
- Always keep children and infirm persons away from the appliance when it is in use.
- Only use the appliance for preparing food.
- Use a deep pan, large enough to cover the appropriate burner.
- Always dry food thoroughly before placing it in hot oil or fat. Frozen food in particular will spit and splatter if added too quickly.
- Never fill the pan more than one third full of fat or oil.
- Never heat fat or fry with a lid on the pan.
- Do not fry too much food at once. This lowers the temperature of the oil or fat and results in fatty foods.
- Do not leave hot fat or oil unattended. If overheating occurs, these could catch fire.
- Do not store flammable items in the oven.
- Always keep the oven door gasket clean.
- The lamp(s) used in this appliance is not suitable for household room illumination.

The control panel

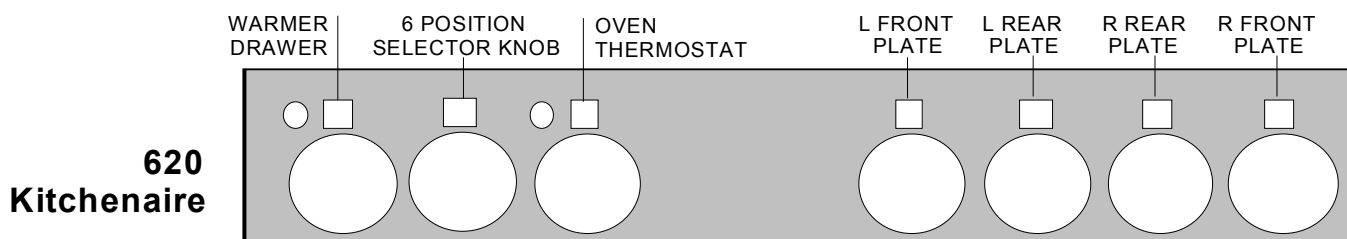
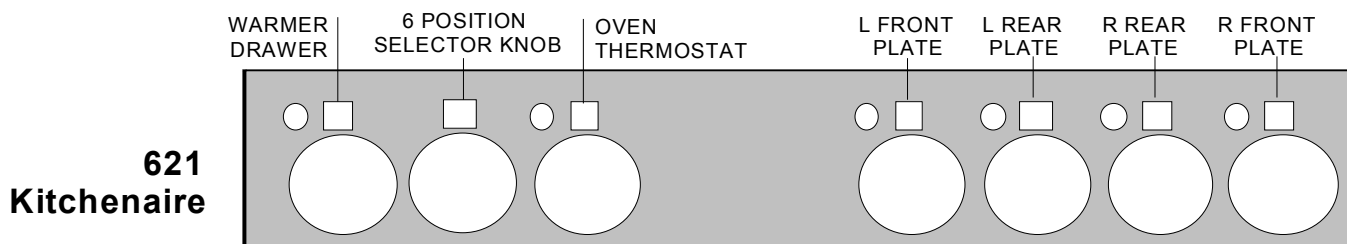

Note: Model 620 has energy regulators controlling the spiral plates and as a result, does not feature plate indicator lights.

6 Position selector knob

Oven Light: To switch on the light, turn the selector knob until the light icon, depicted on the knob, is at the top. The light remains on when any other functions are selected.

Top and Bottom elements (Conventional Bake): Both the bottom bake element and the top heat element are utilised. This position is ideal for baking, roasting and cooking.

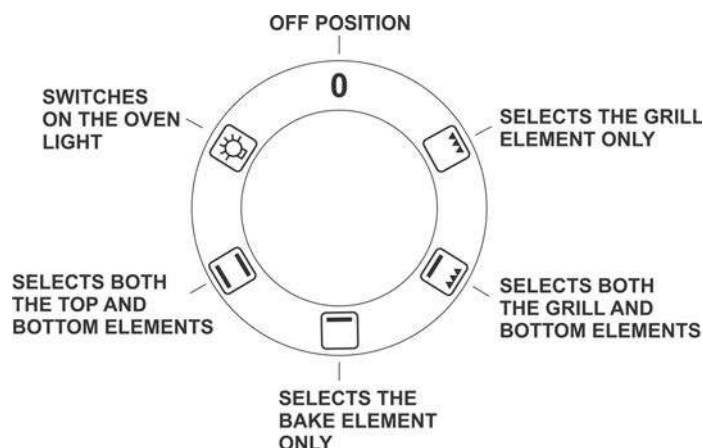

Bottom element only: Selecting only the bottom element **and setting the thermostat at the lowest temperature**, allows the oven to be used as an additional warming space, should the warming drawer be fully utilised.

Grill and bottom elements: (Pre-Heat) Reduces oven heat up time. Select conventional bake when desired temperature has been reached.

Grill: Select the grill function for conventional grilling.

Note: All ovens extract moisture from the food being cooked, especially so during the winter months. This is normal and not detrimental to the food or the oven.

Shelf positions



Baking/Defrost



Roasting

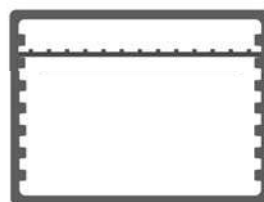

Grilling

Using the oven

Baking

- This product is supplied with one chromed oven shelf and a roast pan. If required, additional shelves, roast pans and a broiler may be purchased from any Defy Service Centre.
- Set the selector knob to the desired baking mode. See descriptions on page 5. Top and Bottom elements or Bottom element only or Top element only.
- Set the oven thermostat to the required temperature.
- The thermostat indicator light will glow and remain on until the oven has reached the selected temperature. The light will then switch off.
- Thereafter place the food in the oven.
- During the baking cycle, the indicator light will switch on and off as the thermostat maintains the selected temperature.
- **After baking is completed, the thermostat and the selector knob must be turned to the "0" position in an anti clockwise direction.**
- **Note: The oven thermostat is marked down to 70°C. When set to this position, the oven may be used as a warmer.**

Baking Guide:

- Where possible, bake on the middle shelf position of the oven.
- Place the food halfway between the back of the oven and the door.
- Do not open the oven door until at least two thirds of the baking time has lapsed.
- **The roast pan is ideal for roasting but should not be used for baking. During baking, the roast pan should be removed.**
- **For best baking results use an aluminium bake tray (380mm x 260mm x 30mm).**
- **Teflon coated baking trays are not recommended.**

Grilling

- **The oven door must remain partially open (approx. 80 mm) during grilling.**
- Both the wire shelf and roast pan/shelf may be used for grilling.
- The roast pan may also be used as a drip tray under the wire shelf.
- Position the shelf in the desired position below the grill element.
- Set the **selector switch** and **oven thermostat** to their respective **Grill** positions.
- The thermostat indicator light will glow.
- Pre-heat the grill element for about 5 minutes.
- Partially withdraw the shelf and place the food in the centre of the shelf.
- Slide the shelf back into position and partially close the door.
- Monitor the grilling to avoid burning the food.
- After grilling is completed, the **oven thermostat** and the **selector switch** must be returned to the "0" position in an anti-clockwise direction.

WARNING

Accessible parts may become hot when grilling. Always use oven gloves when handling food in the oven and keep children well away from the stove when it is in use.

Solid plates (621 Kitchenaire)

Red dot plates

- Plates featuring a red dot in the centre are high speed, high wattage plates for increased performance
- For your safety these plates are fitted with thermal limiters. Should a plate be accidentally switched on and left unattended, the limiter will reduce the power output of the plate and minimise the risk of overheating and the possibility of fire.

Caring for Solid Plates

- Before using the plates for the first time, switch them on for about 4 minutes at the highest setting. This allows the factory applied protective coating to burn in.
- To prevent blotchy discolouration and corrosion, moisture from splatters and spills should be cleaned off immediately.
- To clean the plates, wipe them with a damp cloth or nylon pad. A little liquid detergent may be used. Do not use metal scourers or sharp metal objects to clean the plates.
- After cleaning, dry the plates by switching them on for a short while.
- **To prevent rust, periodically apply some, sewing machine oil or electrical hotplate polish - available from Defy Service Centres. Extra attention is required in areas of high humidity or in close proximity to the sea.**

Recommendations

- Use only pots with a solid level base. An uneven base can prolong cooking times and waste energy.
- Use pots with a base diameter slightly larger than the plate. This will ensure even heat distribution and prevent spillage from dripping onto and staining the hot plate.
- Always cover the pot with a lid. This will conserve energy and minimise spillage.
- Thermal shock could damage the plates. Do not put cold pots on very hot plates.

Plate controls—variable

- Select the heat level by turning the knob to the required setting.
- You may select any setting.
- 1= low , 3 = medium and 6 = high.
- The relevant plate indicator light will glow, when the plate is switched on. (model 621 only).



Danger of fire: Do not store items on the cooking surface.
CAUTION: The cooking process has to be supervised. A short term cooking process has to be supervised continuously.
WARNING: Unattended cooking on a hob with fat or oil can be dangerous and may result in a fire.

WARNING

The warranty does not cover the replacement or repair of rusted or corroded plates.

Spiral plates (620 Kitchenaire)

Spiral plate control knobs.

- The plate will operate at any setting between minimum and maximum as depicted on the control knob. With a little experience you will soon find the ideal position for:
- Gentle simmer to simmer.
- Fast simmer to medium heat
- Hot to maximum heat

Note: To switch plate “ON” rotate the dial knob in a clockwise direction to the required setting. To switch plate “OFF” rotate the dial knob in a counter clockwise direction to the “0” position.

Spiral plate care.

- Use pots with a base diameter slightly larger than the plate. This will ensure even heat distribution and prevent spillage from dripping onto and staining the plate.
- Always cover the pot with a lid as this will conserve energy and minimise spillage.

Cleaning spiral plates.

- Switch off the electrical supply point to the stove.
- When the plates are cold, lift the hinged spiral plate up and remove the supports, under-cups and trims.
- Use hot soapy water to clean the plates, plate supports, trims and under-cups.
- Use a nylon brush on badly soiled items.
- Wipe dry after cleaning and replace items.

Warming drawer

- The warming drawer has a rotary on off switch control.
- On models 620 and 621 only, an indicator light will glow when the drawer has been switched on.
- Food left for too long in the warmer drawer could dry out and spoil. As a precaution food should always be covered, to minimise the drying effect.
- The drawer can be removed for cleaning purposes.
- Pull the drawer out to the bump- stop, then lift the front slightly and continue pulling till the drawer slides free.
- Refit by lifting the rear of the drawer over the bump-stop and then sliding it back.

Maintenance

General cleaning

- Switch off the electrical power supply before cleaning any part of the appliance.
- Wipe down glass panels, cabinet, door, control knobs, trims and handles with a hot soapy cloth. Do not use a steam cleaner.
- Use only liquid household cleaners and avoid abrasive powders, scouring pads and caustic cleaners.
- Rinse and wipe down with a clean cloth.

Cleaning the oven

- Switch off the electrical power supply before cleaning any part of the appliance.
- Open the oven door and allow the oven to cool down.
- For improved access, the shelf, roast pan and oven door may be removed.
- Clean the oven with a damp, hot soapy cloth. Do not use a steam cleaner.
- It may be necessary to soak burnt soils with a liquid cleaner to soften them before scrubbing them with a nylon brush or scouring sponge.
- Heavy soils on the bottom of the oven may require overnight soaking under a sponge liberally sprinkled with household ammonia. The soil can then be removed the following morning by washing normally.
- Do not use metal objects or steel wool to clean the oven.
- After cleaning, fit the bottom element into the hooks of the element guard. Failure to observe this precaution would allow the element to rest on and possibly damage the oven enamel.

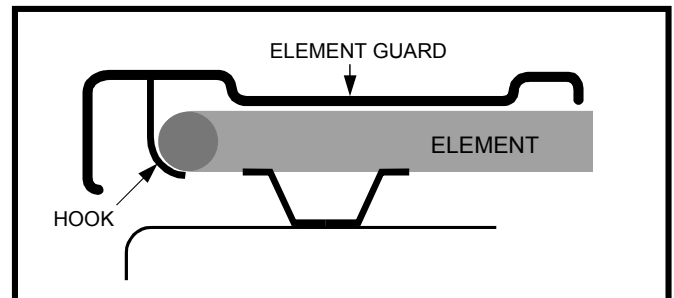

Oven light

The oven light is switched on by the oven thermostat and switches off when the thermostat knob is returned to 0.

To replace a faulty light bulb, proceed as follows.

- Switch off the power at the wall isolator to avoid the possibility of electric shock.
- Remove the light cover by unscrewing it in an anti-clockwise direction
- Unscrew the faulty bulb and fit a new 25 watt bulb rated for 300°C
- Refit the light cover.

Removable oven door

The oven door may be removed to improve access to the oven for cleaning purposes.

- 1 Open the door fully to expose the hinges (A) on either side.
- 2 Flip the hinge locking levers (B) to the upright position.
- 3 Partially close the oven door and lift it free of the side panel retaining slots.
- 4 After cleaning, re-fit the oven door in reverse order making sure that the bottom hinge notches © locate properly onto the bottom edges of the side panel retaining slots.

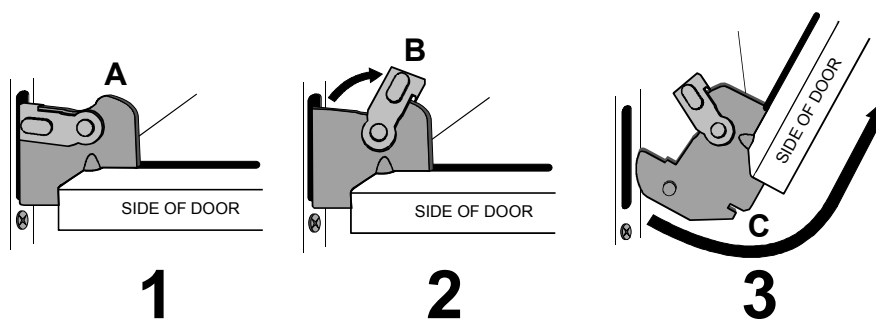

Owner's responsibility

Since the following are not factory faults, they are the owner's responsibility.

- Damage to exterior finish.
- Breakage of glass and other components.
- Replacement of the light bulb.
- Damage through improper installation or use of the appliance.
- Damage caused by moving the appliance.



OVER THE YEARS, DEFY'S SERVICE CENTRES HAVE IDENTIFIED THIS LIST OF DO'S AND DON'TS AS BEING IMPORTANT FOR CUSTOMER SATISFACTION AND SAFETY. PLEASE READ IT AND FAMILIARISE YOURSELF WITH ITS CONTENTS.



Do





- Clean your appliance regularly. This will prolong its good looks and enhance hygiene levels.
- Use flat bottomed pots and pans when cooking on the hotplates. This will maximise efficiency and reduce electricity costs.
- Keep children well away from the cooking appliance. Explain the dangers to them. Being safety conscious is being safe, not sorry.
- Supervise the cooking process. Overcooked or spoiled food is wasteful.
- Leave about a 40 mm. air gap between baking tins and the oven walls. Adequate air circulation is important for good baking results.
- Get into the habit of wearing oven gloves when handling utensils in a hot oven. This will help to avoid accidental burns.
- Partly slide out the oven shelf before removing hot dishes from the oven. This will prevent accidental contact with the hot oven sides.

Don't

- Use pots which are smaller than the hotplate diameter. This wastes electricity and allows the pot handles to overheat.
- Leave the appliance unattended especially when grilling. This is good practice and avoids accidents.
- Place anything on the open oven door. The glass is not a work surface and could get scratched.
- Use abrasive cleaning materials. They will scratch surfaces and fascia graphics.
- Allow fat splashes to dry and bake onto the stove/oven surface before cleaning them. It is easier to clean spills while they are still slightly warm and soft.
- Put baking tins on the floor of the oven. This will prevent heat circulation and spoil baking results.
- Use the appliance to heat the home. Neither the hotplates nor the oven were designed for this purpose and damage could occur.
- Allow pot handles to overhang the front of the appliance. Children might be tempted to grab them with harmful consequences.

	Figures in this manual are schematic and may not match your appliance exactly.
	DANGER Risk of scalding by hot steam! Take care when opening the oven door as steam may escape.
	

	WARNING Hot surfaces may cause burns! Do not touch the hot surfaces of the appliance. Use oven gloves. Keep children away from the appliance.
	DANGER Risk of fire by overheated oil! When heating oil, do not leave it unattended. Never try to extinguish a fire with water! When oil has caught fire, immediately cover the pot or pan with a lid. Switch off the hob if safe to do so and phone the fire service.
	

	WARNING: Under no circumstances should the bake element be covered with aluminium foil. Nor should a pan or tray be positioned directly above the bake element.	
	Doing so would reflect the heat from the bake element downwards. Heat to the oven would be restricted and overheating of the space below the element would result in damage to the oven enamel.	

Problem check

Do not attempt any repairs yourself.

Before calling a service technician to assist with a problem, please check:

- The mains distribution board for tripped circuit breakers.
- The wall switch is on.

Remember that you may be charged for a service call even during the warranty period if the fault is due to or caused by any of the above.

Branches

If you have followed the instructions and still have a problem, contact the customer care line on 086 100 3339. They will be able to advise you on any aspect of the appliance.

South African Branches:

BLOEMFONTEIN

160 Long Street, Hilton, Bloemfontein 9301
Bloemfontein.Service@defy.co.za

CAPE TOWN

5A Marconi Rd. Montague Gardens, 7441
CapeTown.Service@defy.co.za

DURBAN

135 Teakwood Road, Jacobs,
Durban, 4052
Durban.Service@defy.co.za

EAST LONDON

Robbie de Lange Road, Wilsonia,
East London, 5201
EastLondon.Service@defy.co.za

JOHANNESBURG

Cnr. Mimetes & Kruger Sts. Denver ext.12
Johannesburg, 2094
Gauteng.Service@defy.co.za

POLOKWANE

87 Nelson Mandela Drive, Superbia 0699
Polokwane.Service@defy.co.za

PORT ELIZABETH

112 Patterson Road, North End, Port Elizabeth 6001
PortElizabeth.Service@defy.co.za

PRETORIA

Block A1 Old Mutual Industrial Park,
Cnr. D.F.Malan Drive & Moot Str. Hermanstad, 0082
Pretoria.Service@defy.co.za

Sub-Saharan Africa Branches:

ZAMBIA: SOUTHGATE INVESTMENTS LTD

Plot 1606, Sheki Sheki Road
P.O. Box 33681
Lusaka, 10101, Zambia
Tel: +260 0211 242332/3
Fax: +260 0211 242933
sgiservicecentre@microlink.zm

NAMIBIA: ATLANTIC DISTRIBUTORS (PTY) LTD

10 Tienie Louw Street, Northern Industrial Area
P.O. Box 21158, Windhoek, Namibia
Tel: (061) 216162
Fax: (061) 216134
atlantic@mweb.com.na

ZIMBABWE: TRADECOMAFRICA

Trade Com Africa, 183 Loreley Crescent
Msasa, Harare, Zimbabwe
Tel: +263 4 486165/6
Cell: +263 772 469010
Cell: +263 772 469011

BOTSWANA: RAY MORGAN AGENCIES

RMA Service Centre, Plot 48, East Gate
Gaborone International Commerce Park
Kgale View, Gaborone
Botswana
Tel: +267 390 3996 / 390 3912
Fax: +267 318 7376
Cell: +267 7134 6539
service@rma.co.bw; raja@rma.co.bw

SWAZILAND: LYNDS DISTRIBUTORS

P.O Box 716, Mbabane, Swaziland, H100
Tel: (00268) 2515 4310/8
Fax: (00268) 2518 4318

MOZAMBIQUE: COOL WORLD. LDA

Rua da Resistencia No. 97B R/C
Cell: +258 84 44 61 234
coolworldlda@hotmail.com
Nosso Show Room
Av: da Industrias, Parcela No.735 * 735A
Machava, Maputo

WARRANTY

This certificate is issued by DEFY APPLIANCES LIMITED manufacturers of Defy and Ocean products, hereinafter the Company, to the original purchaser only, of the appliance described on the certificate and shall constitute the only warranty given in respect of this appliance.

The Company warrants to the original purchaser that for a period of THREE YEARS from date of purchase the appliance is free from defect under normal domestic use, both in workmanship and material, subject to the following conditions.

1. Repair or replacement of any part of this appliance, found by the Company to be defective, shall be at the election of the Company. The Company reserves the right to effect such service through any of its Service Divisions or Authorised Service Dealers. The cost of such service shall be borne by the Company in full, provided that the appliance is located no further than 50 km from a Company Service Centre or an Authorised Service Dealer. Where the appliance is located beyond the 50 km radius, the purchaser shall be liable for the standard travelling charges, as determined by the Company.
CARRY IN SERVICE Microwave ovens, Compact cookers and small appliances are repaired in our service centres and are not collected from the customers home. Faulty units should be delivered to the purchasing dealer or to the nearest Company Service Centre for warranty repairs.
2. Rusted or corroded solid plates, vitreous enamelware, fuses and lamps are specifically excluded from these warranties. It is an express condition of these warranties that the purchaser takes due care and attention in the use and maintenance of the appliance. Abuse, misuse in conflict with operating instructions, connection to incorrect voltages and subjection to commercial use shall release the Company from its obligations.
3. This warranty shall become void and cease to operate if the appliance is dismantled by, or any repairs to the appliance are effected by any persons not duly authorised by the Company, or if substitute parts not approved by the Company are used in the appliance, or if the serial number of the appliance is removed.
4. The Company shall not be responsible for damages resulting from fire, flood, civil disturbances or any Act of God. The Company shall not, in terms of these warranties be responsible nor held liable for any consequential loss or damage of any kind caused by or due to the failure or malfunction of the appliance. The Company shall not be responsible for damages caused by insect and/or animal infestation.
5. The Company shall not be responsible for transportation or other costs other than those incurred within the provisions of Point 1 of this Certificate.
6. **For warranties in the Republic of South Africa and Sub-Saharan Africa, please contact the customer care line. Please refer to the previous page for respective South African branches and Sub-Saharan Africa branches.**
7. Where service is requested under warranty and no fault or defect can be found by the Company, all costs incurred will be for the purchaser's account.
8. This Certificate as well as your invoice will serve as proof of purchase. For the purpose of warranty, it will be essential to produce this Certificate and invoice. Failure to do so, will render the purchaser liable for service costs.

**KEEP THIS CERTIFICATE AND SALES INVOICE AS PROOF OF PURCHASE
FOR WARRANTY PURPOSES.**

For future reference, record the listed information in the space below. The Serial number may be found on the label located at the upper back panel.

SERIAL No.....

DATE OF PURCHASE.....

PURCHASED FROM.....