

G10750 NE
4 DOOR SBS REFRIGERATORS

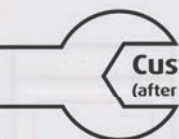

Believe in better



Customer Care Line
(after sales service)

086 100 3339

Part number: 3827220100 AD



Refrigeration
Instruction manual

Read this manual before initial installation and operation of the refrigerator!

Dear Customer,

Your new Defy refrigerator was manufactured in a state of the art facility and has passed the strictest quality control procedures.

Please read this manual carefully before using your product for the first time and then store it within easy reach for future reference.

We trust you will enjoy years of trouble free use.

The user manual:

- This manual will provide you with information on how to safely operate and care for your refrigerator in order that you gain the maximum benefit from it.
- Pay particular attention to any safety instructions.
- Please read all additional documents supplied with your product.
- Please note that this manual may be used for several similar but different models. Please check for relevance regarding your particular model.

Explanation of symbols used in this manual



Important safety information. Warning for hazardous situations with regard to life and property.



Caution; Warning for supply voltage.



Caution; Warning for fire hazard.



Useful information. Important information or useful hints about usage.



Unpacking: Remove all packaging.

Ensure that packing material is disposed of in a responsible manner and that any plastic bags are cut up to prevent children playing with them and accidentally suffocating.

If the refrigerator is damaged in any way do not use it. Report the damage to your dealer who will take the necessary corrective action.

The manufacturer strives for continuous improvement. For this reason, the text and illustrations in this manual are subject to change without notice.

Contents

1 Important safety information	4	5 Using the product	13
Warnings	4	Indicator panel	13
For models with water fountain	4	Using the water dispenser	18
Child safety	6	Drip tray	18
HCA warning	6	Cleaning the water tank	19
2 Your Refrigerator	7	Freezing fresh food	20
3 Installation	8	Recommendations for storing frozen foods	20
Installation location	8	Deep freezer details	20
Attaching the plastic wedges	8	Placing food	21
Adjusting the feet	9	Door open alert	21
Power connection	9	Interior light	21
Adjusting the gap on the upper door	10	Chiller compartment	21
4 Preparation	11	Crisper	21
Things to be done for energy saving	11	Egg tray	22
Initial use	12	Moveable middle section	22
		Blue light	22
		Odour filter	22
		Ionizer	22
		6 Maintenance and cleaning	23
		Preventing bad odour	23
		Protecting plastic surfaces	23
		7 Troubleshooting	24
		8 Branches	27
		9 Warranty	28

1 Important safety information

Please review and observe the following information. Failure to do so may result in injuries or material damage and will render any warranty and reliability commitments void.

Warnings

- The refrigerator must only be used for its intended purpose, i.e. storing of edible foodstuff.
- The refrigerator is intended to be used in household and similar applications such as staff kitchen areas in shops, offices and other working environments; farm houses and by clients in hotels, motels and other residential type environments; bed and breakfast type environments; catering and similar non-retail applications.
- This appliance is not intended for use by persons (including children) with reduced physical, sensory or mental capabilities, or lack of experience and knowledge, unless they have been given supervision or instruction concerning use of the appliance by a person responsible for their safety.
- Children should be supervised to ensure that they do not play with the appliance.
- In the event of a malfunction, disconnect the refrigerator from the power supply.
- Vapour and vaporized cleaning materials must never be used in the cleaning the refrigerator. The vapour may come into contact with the electrical parts and cause a short circuit or electric shock.
- Do not allow children to hang on the refrigerator doors as the unit could topple forward risking personal injury. Never use the parts on your refrigerator, such as the door, as a means of support or step.
- Keep ventilation openings, in the appliance enclosure or in the built-in structure, clear of obstruction.
- Do not use electrical appliances inside the food storage compartments of the appliance, unless they are of the type recommended by the manufacturer.
- Unplug the refrigerator when cleaning, during routine maintenance or if it will not be used for an extended period.
- To unplug the refrigerator, remove the plug by pulling on the plug and not the cable!
- Never connect your refrigerator to electricity saving systems as they may damage the refrigerator.

- If the supply cord is damaged, it must be replaced by the manufacturer, its service agent or similarly qualified persons in order to avoid a hazard.
- Exposing the refrigerator to rain, snow, sun and wind is an electrical safety risk.
- Do not store medicine or academic research samples which require strict temperature control in the refrigerator.
- Do not store or use flammable gas, benzene, petrol or volatile substances in or near the refrigerator.
- Do not store explosive substances such as aerosol cans with a flammable propellant in the refrigerator.
- Do not overload your refrigerator with large amounts of food. If overloaded, the food may fall down and injure you and damage the refrigerator when opening the door. Never place objects on top of the refrigerator, they may fall and injure you when you open or close the refrigerator door.
- The refrigerator may move if the adjustable legs are not properly levelled on the floor. Levelling the adjustable legs on the floor helps prevent the refrigerator from moving.
- If there is a blue light fitted on the refrigerator, do not look at the blue light through optics.
- When carrying the refrigerator, do not hold on the door handle as the handle may break.
- When placing your refrigerator next to another refrigerator or freezer, the distance between the devices must be at least 8 cm. Failure to do so may cause adjacent walls to humidify.
- Do not put bottled or canned liquid beverages in the freezer compartment: they may burst.
- Do not touch frozen food with your hands; it may stick to your hands.
- Never pour or spray water into or on the refrigerator and do not store liquids, pot plants or open containers on top of the refrigerator as these may spill causing electrical shorting.
- Avoid any damage to the power cable when transporting the refrigerator.
- Bending the cable may cause a fire.
- Never place heavy objects on the power cable.
- Do not touch the plug with wet hands.
- Contact a Defy service centre for all questions and problems relating to the refrigerator.
- The lamp(s) used in this appliance is not suitable for household room illumination.
- If the product has LED type lighting, contact the Defy service centre for replacing or in case of any problem.

- Do not plug in the refrigerator if the wall socket is loose.
- On delivery, check to make sure that the refrigerator is not damaged and that all the parts and accessories are in perfect condition.
- Ensure that the plug remains readily accessible. Do not use multiple adapter plugs or an extension cable.
- Ensure that there is sufficient spacing between the refrigerator and surrounding walls.





Child safety

- If the door has a lock, keep the key out of reach from children.
- If you are discarding an old refrigerator with a lock or latch fitted to the door, disable the lock/latch, and ensure that the refrigerator is left in a safe condition to prevent children from being trapped inside and suffocating.
- Children must be supervised to prevent them from tampering with the refrigerator.

HCA Warning

Refrigerator cooling systems containing R600a: This refrigerator contains non CFC/ HFC natural substances in the cooling system (Called R600a) and in the insulation (Called cyclopentane). These are potentially flammable if exposed to fire. Take care not to damage

the cooling circuit / pipes of the refrigerator in transportation and in use. In case of damage do not expose the refrigerator to fire or potential ignition sources and immediately ventilate the room where the refrigerator is situated. Ignore this warning if your refrigerators cooling system contains R134a.

	Do not drill, cut or modify the refrigerator. Injuries may result if the refrigerant circuit is damaged. WARNING: Do not damage the refrigerant circuit.
	Do not operate a damaged refrigerator. Contact the nearest Defy service center.
	The electrical safety of the refrigerator is only guaranteed if the earth system of your home is compliant to national standards.
	Repairs must be carried out by authorised persons only. Repairs carried out by incompetent persons create a user risk.
	Never plug the refrigerator into the wall socket during installation. Death or serious injury may result.

2 Your Refrigerator

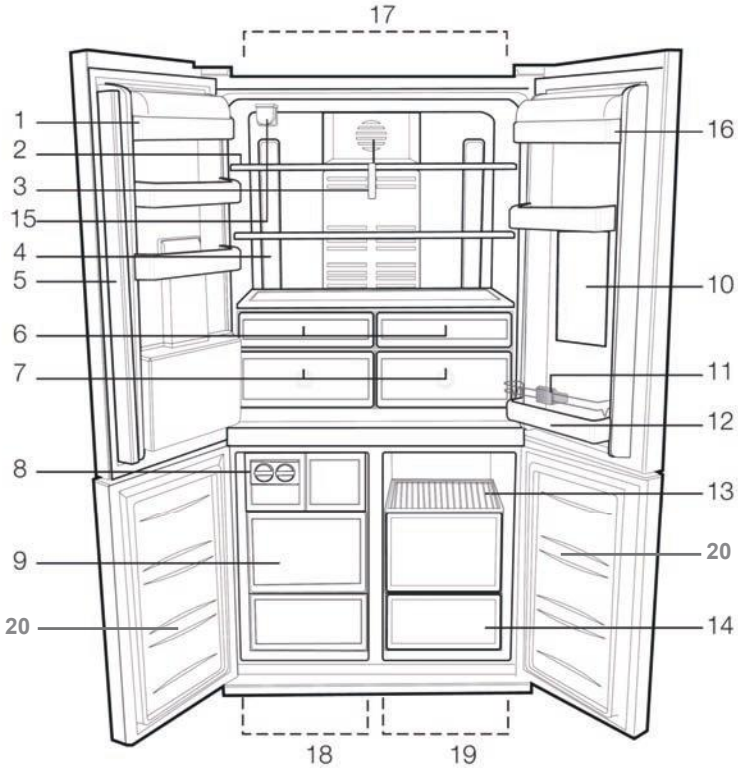

- 1- Fridge compartment door shelves
- 2- Fridge compartment glass shelves
- 3- Diffuser cover*
- 4- Illumination lens
- 5- Movable middle section
- 6- Chiller compartment*
- 7- Crisper
- 8- Icebox & icebox drawer*
- 9- Frozen food storage compartments*

- 10- Minibar*
- 11- Bottle holder*
- 12- Bottle shelf
- 13- Food storage compartment shelves
- 14- Food storage compartments
- 15- Water Filter*
- 16- Dairy compartment*
- 17- Fridge compartment
- 18- Freezer compartment
- 19- Multi Zone*
- 20- Freezer shelves*

***Optional**





***Optional:** Figures in this user guide are schematic and may not be exactly match your product. If your product does not comprise the relevant parts, the information pertains to other models.

3 Installation

Installation location

In order to prepare the product for use, refer to the information in the user manual and ensure that electrical installation is appropriate. If not, call a qualified electrician to have any necessary arrangements carried out.

	WARNING: The manufacturer assumes no responsibility for any damage caused by the work carried out by unauthorized persons.
	WARNING: The product's power cable must be unplugged during installation. Failure to do so may result in death or serious injuries!
	WARNING: If the door span is too narrow for the product to pass through, remove the door and turn the product sideways; if this does not work, contact the customer care line.

- Place the product on a flat surface to avoid vibration.
- Place the product at least 30 cm away from heaters, stoves and similar sources of heat and at least 10 cm away from electric ovens.
- Do not expose the product to direct sunlight or keep in damp environments.
- The product requires adequate air circulation to function efficiently. If the product will be placed in an alcove, remember to leave at least 10 cm distance between the product and the ceiling and the walls.
- Do not install the product in environments with temperatures below 10°C.
- Please ensure that there is a 10 cm air gap right round the fridge.

Attaching the plastic Spacers

Use the plastic spacers provided with the product to provide sufficient space for air circulation between the product and the wall.

1. To attach the spacers, remove the screws on the product and use the screws provided with the spacers.

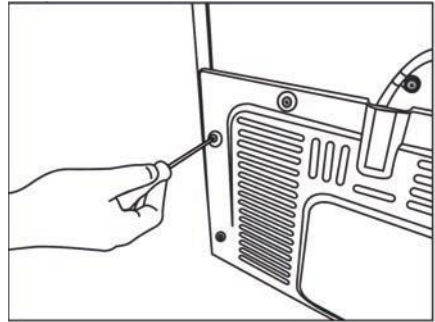

2. Attach the 2 plastic spacers on the ventilation cover shown as in the figure.

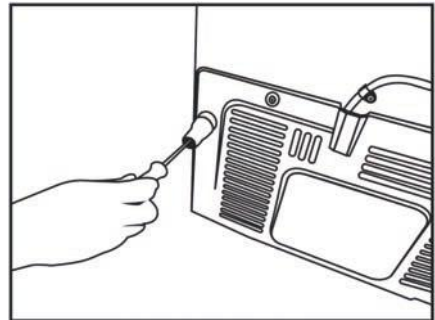



Installation

Adjusting the feet

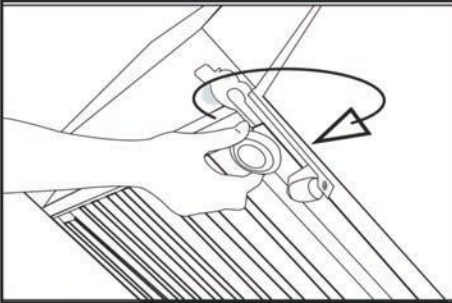
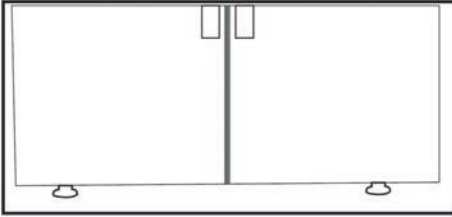
- If the product is not in a balanced position, adjust the front adjustable feet by rotating right or left.



Power connection

	WARNING: Do not use extension or multi sockets in the power connection.
	WARNING: Damaged power cable must be replaced by authorized service.

- Our firm will not assume responsibility for any damages due to usage without earthing and power connection in compliance with national regulations.
- The power cable plug must be easily accessible after installation.
- Connect the refrigerator to an earthed socket with 220-240V/50 Hz voltage. The plug must comprise a 10-16A fuse.
- Do not use a multi-group plug with or without an extension cable between the wall socket and the refrigerator.

Adjusting the gap on the upper door

You can adjust the gap between the fridge compartment doors as illustrated in the figures.

The door shelves should be empty when adjusting the door height.

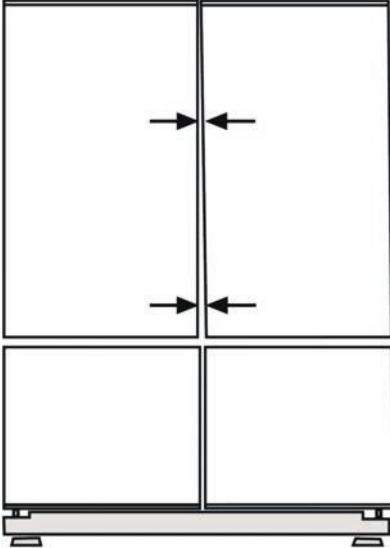

Using a screwdriver, remove the 2 screws of the upper hinge cover of the door you want to adjust.

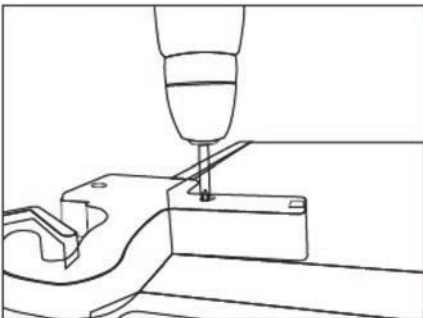

Adjust the door as required by loosening the screws. Set the door you have adjusted by tightening the screws. Be careful not to change the door position whilst tightening the screws.

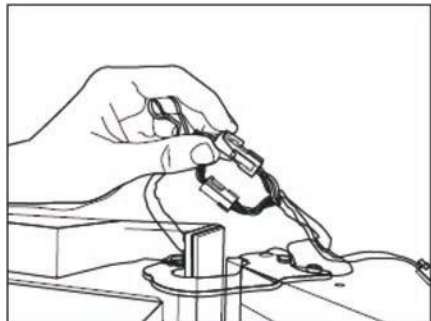
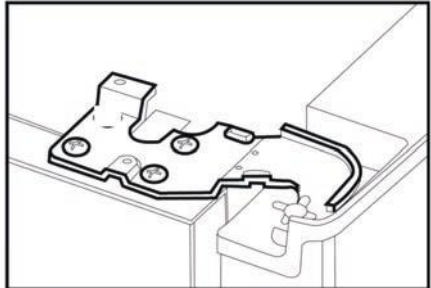
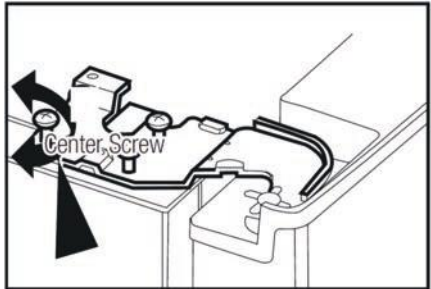
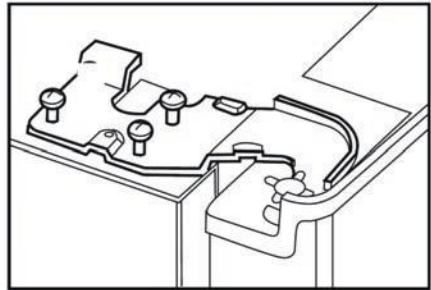

After reattaching the wiring sockets, refit the hinge cover and fasten with the 2 securing screw.

4 Preparation

Things to be done for energy saving



Connecting the product to electronic energy-saving systems is harmful, as it may damage the product.

- Do not leave the doors of your refrigerator open for a long time.
- Do not put hot food or drinks in your refrigerator.
- Do not overload the refrigerator. Cooling capacity will fall when the air circulation in the refrigerator is hindered.
- Do not place the refrigerator in places subject to direct sunlight. Install the product at least 30 cm away from heat sources such as hobs, ovens, heater units and stoves and at least 5 cm away from electrical ovens.
- Pay attention to store food in the refrigerator in closed containers.
- For storage flexibility it is OK to remove some freezer compartment drawers. Power consumption stated for your refrigerator has been determined after removing the icematic and the upper drawers as to allow maximum loading.
- Airflow should not be blocked by placing foods in front of the freezer and the multizone compartment fans. Foods should be loaded by leaving minimum 5 cm space in front of the protective fan grid.
- Thawing frozen foods in the fridge compartment both saves energy and preserves the quality of the foods.



Temperature of the room where your refrigerator is located should at least be 10°C /50°F. Operating your refrigerator under cooler conditions is not recommended with regard to its efficiency.

Inside of your refrigerator must be cleaned thoroughly.

If two coolers are to be installed side by side, there should be at least 10 cm distance between them.

Recommendations for the fresh food compartment

- Make sure that the food does not touch the temperature sensor in fresh food compartment. To allow the fresh food compartment to keep its ideal storage temperature, the sensor must not be hindered by food.
- Do not place hot foods or beverages inside the product.

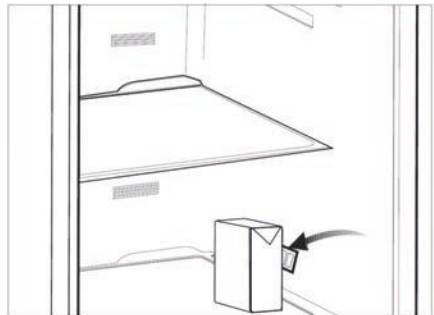
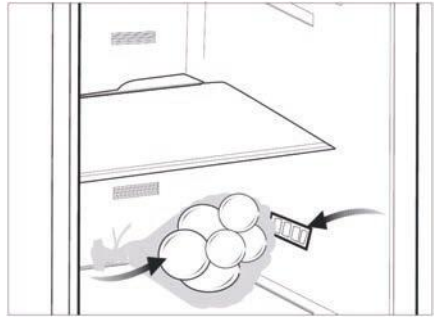

Ensure the fridge contents do not touch the back wall of the refrigerator to prevent them from freezing.

Initial use

- Before using the product, make sure that all preparations have been made in accordance with the instructions given in the "Important instructions regarding safety and environment" and "Installation" chapters.
- Clean the interior of the refrigerator as recommended in the "Maintenance and cleaning" section. Before you start the refrigerator, make sure that the interior is dry.
- Plug the refrigerator in a grounded socket. The interior illumination is lit when the door of the refrigerator is opened.
- Operate the refrigerator for 6 hours without placing any food in it and do not open its door during this time unless it is necessary.

	A sound will be heard when the compressor is engaged. It is normal to hear sound even when the compressor is inactive, due to the compressed liquids and gasses in the cooling system.
	It is normal for the front edges of the refrigerator to be warm. These areas are designed to warm up in order to prevent condensation.

	* Optional: Figures represented in this instruction manual are schematic and may not correspond exactly with your refrigerator. If the parts are not included in the refrigerator you have purchased, they may be model specific and therefore only valid for some models.
--	---

5 Using the product

Indicator panel

Indicator panels may vary depending on the model of your product.

Audial and visual functions of the indicator panel will assist in using the refrigerator.

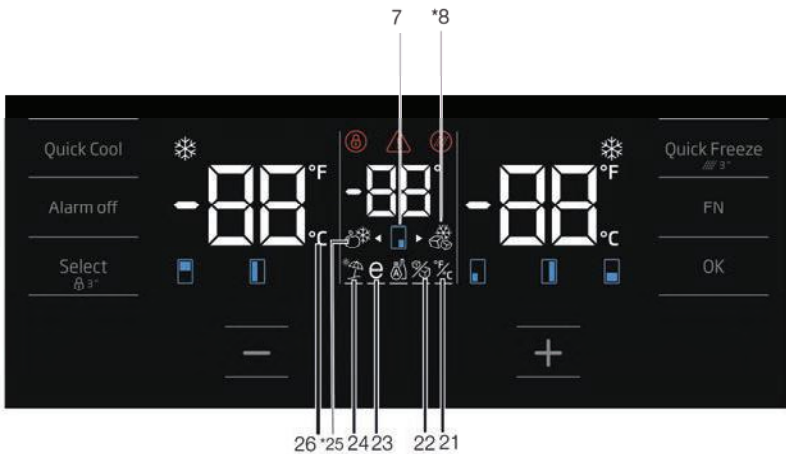
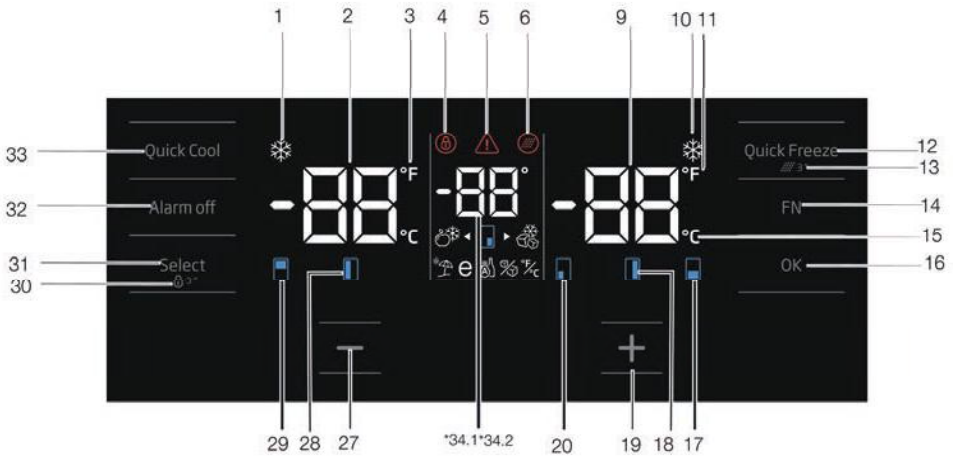

*** Optional:** Figures represented in this instruction manual are schematic and may not correspond exactly with your refrigerator. If the parts are not included in the refrigerator you have purchased, they may be model specific and therefore only valid for some models.

Using the product

1. Quick cooling function indicator

Switches on when the quick fridge function is activated.

2. Fridge compartment temperature indicator

Temperature of the fridge compartment is shown; it may be set to 8,7,6,5,4,3,2,1.

3. Fahrenheit indicator

When the Fahrenheit indication is activated, the temperature set values are shown in Fahrenheit and the relevant icon switches on.

4. Key lock

Press key lock button continually for 3 seconds. The Key lock symbol will light up and key lock mode will be activated. Buttons will not function if the Key lock mode is active. Press the key lock button continually for 3 seconds again. The Key lock symbol will switch off and the key lock mode will exit. Press the key lock button to prevent changing of the temperature setting of the refrigerator.

5. Power failure/High temperature / error warning

This indicator illuminates during power failure, high temperature failures and error warnings. During long-term power failures, the highest temperature value that the freezer compartment reaches will flash on the digital display. After checking the food located in the freezer compartment, press the alarm off button to clear the warning. Please refer to "solutions recommended for troubleshooting" section on your manual if you observe that this indicator is illuminated.

6. Filter reset icon

This switches on when the filter needs to be reset.

7. Temperature change cabin icon

Indicates the cabin whose temperature is to be changed. When the temperature change cabin icon starts flashing, it indicates that the relevant cabin has been selected.

8. Multizone freezer icon (Optional)

Highlight the Multizone freezer icon using the FN button; the icon will start to flash. When you press the OK button, Multizone cabin freezer icon will switch on and the zone operates as a freezer.

9. Freezer compartment temperature indicator

Temperature of the fridge compartment is shown; it can be set to -18, -19, -20, -21, -22, -23, -24.

10. Quick freeze function indicator

It switches on when the quick freeze function is activated.

11. Fahrenheit indicator

When the Fahrenheit indication is activated, the temperature set values are shown in Fahrenheit and the relevant icon switches on.

12. Quick freeze function button

Press this button to activate or deactivate the quick freeze function. When you activate the function, the freezer compartment will be cooled to a temperature lower than the set value.

	Use the quick freeze function when you want to quickly freeze the food placed in the freezer compartment. If you want to freeze large amounts of fresh food, activate this function before putting the food into the product.
	If you do not cancel it, Quick Freeze will cancel itself automatically after 4 hours or when the fridge compartment reaches the set temperature.
	This function is not recalled when power restores after a power failure.

13. Filter reset

The filter is reset when the quick freeze button is pressed for 3 seconds. Filter reset icon goes off.

14. FN button

Use this button to switch between functions that you would like to select. Upon pressing this button, the icon indicator starts flashing of the function that will be activated or deactivated. The FN button will deactivate if not pressed for 20 seconds. Press this button again to change the functions.

Using the product

15. Celsius indicator

When the Celsius indication is activated, the temperature set values are shown in Celsius and the relevant icon switches on.

16. OK button

After navigating functions using the FN button, when a function is cancelled via the OK button, the relevant icon and the indicator flashes. When the function is activated, it remains on. The indicator continues to flash showing it is on.

17. Temperature change cabin icon

Indicates the cabin whose temperature is to be changed. When the temperature change cabin icon starts flashing, it is understood that the relevant cabin has been selected.

18. Temperature change cabin icon

Indicates the cabin whose temperature is to be changed. When the temperature change cabin icon starts flashing, it is understood that the relevant cabin has been selected.

19. Set increasing button

Select the relevant cabin with the select button; the cabin icon representing the relevant cabin will start to flash. If you press the set increasing button during this process, the set value increases. If you keep pressing it in a loop, the set value returns to the beginning.

20. Temperature change cabin icon

Indicates the cabin whose temperature is to be changed. When the temperature change cabin icon starts flashing, it indicates that the relevant cabin has been selected.

21. Setting the Celsius and Fahrenheit indicator

Highlight this button using the FN button and select Fahrenheit and Celsius via the OK button. When the relevant temperature type is selected, the Fahrenheit and Celsius indicator switches on.

22. Ice machine off icon (Optional)

Press the FN button (until it reaches the ice icon and the lower line) to switch off the ice machine. The ice machine off icon and the ice machine function indicator start flashing when you highlight them, indicating whether the ice machine is either on or off.

When you press the OK button, the ice machine icon lights continuously and the Indicator continues to flash during this process. If you do not press any button after 20 seconds, the icon and the indicator remains on. Thus, the ice machine is switched off. In order to switch on the ice machine again, highlight the icon and the indicator; both the ice machine off icon and the indicator will start flashing. If you do not press any button within 20 seconds, the icon and the indicator will go off and the ice machine will be switched on again.

	Indicates whether the icematic is on or off.
	Water flow from water tank will stop when this function is selected. However, ice made previously can be taken from the icematic.

23. Eco fuzzy function icon

Press the FN button (until it reaches the letter “e” icon and the lower line) to activate the eco fuzzy. When you highlight the eco fuzzy icon and the eco fuzzy function indicator, they start flashing. Thus, you can understand whether the eco fuzzy function will be activated or deactivated. When you press the OK button, the eco fuzzy function icon lights continuously and the Indicator continues to flash during this process. If you do not press any button after 20 seconds, the icon and the indicator remains on. Thus, the eco fuzzy function is activated. In order to cancel the eco fuzzy function, Highlight the icon and the indicator again and press the OK button. Thus, both the eco fuzzy function icon and the indicator will start flashing. If you do not press any button within 20 seconds, the icon and the indicator will go off and the eco fuzzy function will be cancelled.

Using the product

24. Vacation function icon

Press the FN button (until it reaches the umbrella icon and the lower line) to activate the vacation function. When you highlight the vacation function icon and the vacation function indicator, they start flashing. This shows whether the vacation function is activated or deactivated. When you press the OK button, the vacation function icon lights continuously indicating that the Vacation function is activated. The Indicator continues to flash during this process. Press the OK button to cancel the vacation function. Both the vacation function icon and the indicator will start flashing and the vacation function will be cancelled.

25. Multizone fridge icon (Optional)

When you select the Multizone fridge icon using the FN button and press the OK button, the Multizone cabin switches into a fridge cabin and operates as a cooler.

26. Celsius indicator

When the Celsius indication is activated, the temperature set values are shown in Celsius and the relevant icon switches on.

27. Set decreasing function

Select the relevant cabin with the select button; the cabin icon representing the relevant cabin will start to flash. If you press the set decreasing button during this process, the set value decreases. If you keep pressing it in a loop, the set value returns to the beginning.

28. Temperature change cabin icon

Indicates the cabin whose temperature is to be changed. When the temperature change cabin icon starts flashing, it indicates that the relevant cabin has been selected.

29. Temperature change cabin icon

Indicates the cabin whose temperature is to be changed. When the temperature change cabin icon starts flashing, it indicates that the relevant cabin has been selected.

30. Key lock

Press key lock button simultaneously for 3 seconds. Key lock symbol will light up and key lock mode will be activated. Buttons will not function if the Key lock mode is active. Press key lock button simultaneously for 3 seconds again. Key lock symbol will turn off and the key lock mode will be exited.

Press the key lock button if you want to prevent changing of the temperature setting of the refrigerator.

31. Select button

Use this button to select the cabin whose temperature you want to change. Switch between the cabins by pressing this button. The selected cabin can be understood from the cabin icons (7,17,18,20,28,29).

Whichever cabin icon is flashing, the cabin, whose temperature set value you want to change, is selected. Then, you can change the set value by pressing the cabin set value decreasing button (27) and the cabin set value increasing button (19). If you do not press the select button for 20 seconds, the cabin icons will go off. Press this button to select a cabin again.

32. Alarm off warning

In case of power failure/high temperature alarm, after checking the foods in the freezer compartment, press the alarm off button to clear the warning.

33. Quick cooling function button

The button has two functions. To activate or deactivate the quick cool function, press it briefly. The Quick Cool indicator will switch off and the product will return to its normal settings.



Use quick cooling function when you want to quickly cool the food placed in the fridge compartment. If you want to cool large amounts of fresh food, activate this function before putting the food into the product.

Using the product

	If you do not cancel it, quick cooling will cancel itself automatically after 8 hours at the most or when the fridge compartment reaches to the required temperature.
	If you press the quick cooling button repeatedly with short intervals, the electronic circuit protection will be activated and the compressor will not start up immediately.
	This function is not recalled when power restores after a power failure.

34. Multizone temperature indicator (Optional)

Temperature set values of the Multizone cabin are displayed.

Please note: Will only allow freezer temperature on models where multizone option is not available.

Using the product

Using the water dispenser (for certain models)

	The first few glasses of water taken from the dispenser will normally be warm.
	If the water dispenser is not used for a long time, dispose of the first few glasses of water to get clean water.

Please wait for approximately 12 hours for cold water after first installation. Use the display* to select the water option (*Using the display to select the water option depends on the model), press the trigger for water flow. Remove the glass shortly after pressing the trigger.

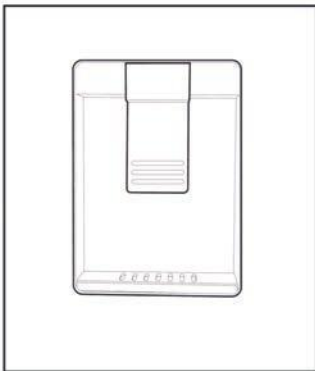

Filling the water dispenser's tank

The water tank filling reservoir is located inside the door rack. Open the reservoir cover and fill up with pure and clean drinking water. Close the cover.

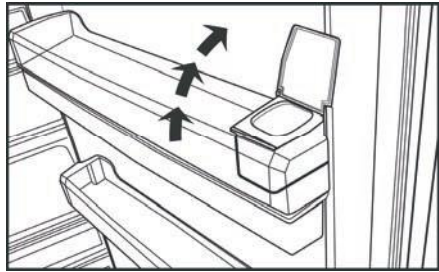
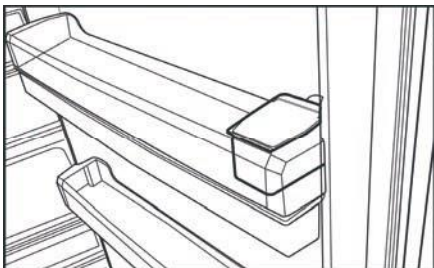

Drip tray

Any water that drips whilst using the water dispenser accumulates in the spillage tray. Remove the plastic strainer by pressing on the side as shown in the figure. With a clean and dry cloth, remove the water that has accumulated.

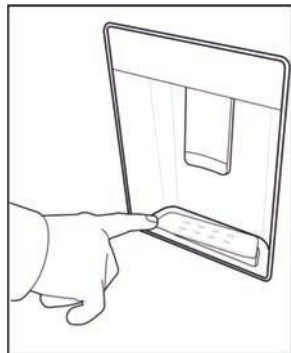

Do not fill the water tank with fruit juice, fizzy beverages, alcoholic beverages or any other liquids incompatible for use in the water dispenser. Using such liquids will cause malfunction and irreparable damage to the water dispenser. Using the dispenser in this way is not covered by the warranty. Certain chemicals and additives in the beverages / liquids may cause material damage to the water tank.

The water tank and water dispenser components cannot be washed with dishwashers.

Using the product

Cleaning the water tank

- Remove the water filling reservoir inside the door rack.

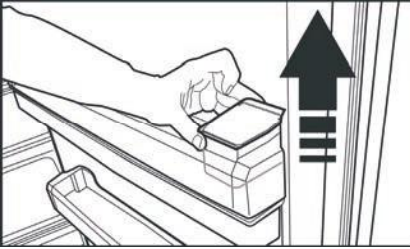

- Remove the water dispenser shelf by holding from both sides.

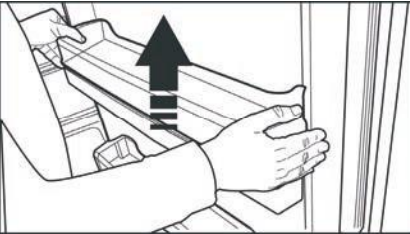

- Grab the water dispenser reservoir on both sides & remove it at an angle of 45°.

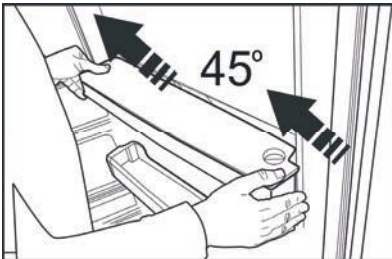

- Clean the reservoir by removing its lid.

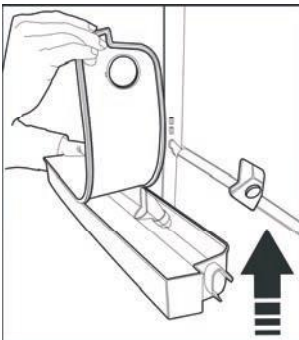

Make sure that the parts and seals removed (if any) as illustrated in the exploded diagram below, during cleaning are properly refitted to prevent any water leakage.

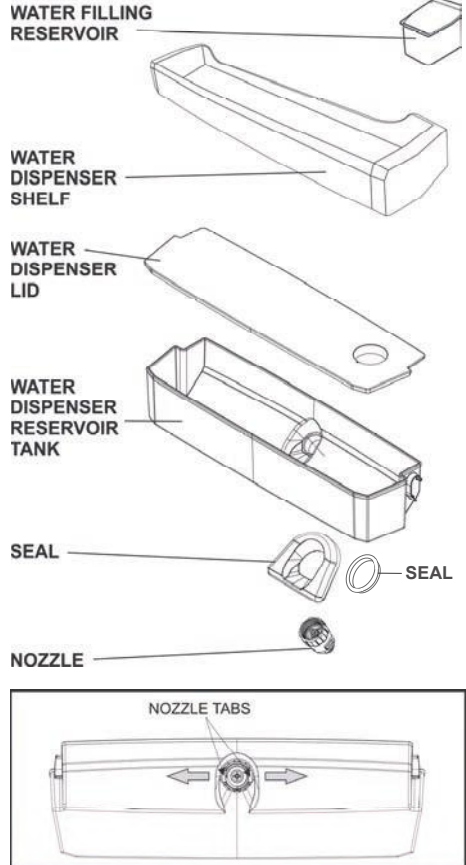

i When fastening the nozzle, please ensure that the nozzle tabs are horizontally aligned with the dispenser housing.

Some condensation may form around the nozzle and drip into the drip tray. This is normal.

Using the product

Freezing fresh food

- To preserve food quality, the food items placed in the freezer compartment must be frozen as quickly as possible, use the rapid freezing for this.
- Freezing food items when fresh will extend the storage time in the freezer compartment.
- Pack the food items in air-tight packs and seal tightly.
- Make sure the food items are packed before putting in the freezer. Use freezer holders, tinfoil and damp-proof paper, plastic bag or similar packaging materials instead of traditional packaging paper.
- Mark each food pack by writing the date on the package before freezing. This will allow you to determine the freshness of each pack every time the freezer is opened. Keep the earlier food items in the front to ensure they are used first.
- Frozen food items must be used immediately after defrosting and must not be frozen again.
- Do not freeze large quantities of food all at once.

Recommendations for storing frozen foods

The compartment must be set to at least -18°C.

1. Place the food items in the freezer as quickly as possible to avoid defrosting.

2. Before freezing, check the “Expiry Date” on the package to make sure it has not expired.
3. Make sure the food’s packaging is not damaged.

Deep freezer details

As per the IEC 62552 standards, the freezer must have the capacity to freeze 4,5 kg of food items at -18°C or lower temperatures in 24 hours for each 100 litres of freezer compartment volume. Food items can only be preserved for extended periods at or below temperatures of -18°C . You can keep the foods fresh for months (in deep freezer at or below temperatures of 18°C).

Food items to be frozen must not come into contact with the already frozen food inside the freezer to avoid partial defrosting of the already frozen food.

Boil the vegetables and filter the water to extend the frozen storage time. Place the food in air tight packages after filtering and place in the freezer. Bananas, tomatoes, lettuce, celery, boiled eggs, potatoes and similar food items should not be frozen. Freezing these food items will simply reduce the nutritional value and food quality, as well as possible spoiling which is harmful to health.

Freezer Compartment Setting	Cooler Compartment Setting	Descriptions
-18°C	4°C	This is the default, recommended setting.
-20,-22 or -24°C	4°C	Recommended for ambient temperatures exceeding 30°C.
Rapid Freeze	4°C	Use this to freeze food items in a short time, the product will reset to previous settings when the process is completed.
-18°C or colder	2°C	Use these settings if you believe the cooler compartment is not cold enough due to ambient temperature or frequently opening the door.

Using the product

Placing food

Freezer compartment shelves	Various frozen goods including meat, fish, ice cream, vegetables etc.
Cooler compartment shelves	Food items inside pots, capped plate and capped cases, eggs (in capped case)
Cooler compartment door shelves	Small and packed food or beverages
Vegetable bin	Fruits and vegetables
Fresh food compartment	Delicatessen (breakfast food, meat products to be consumed at short notice)

Door open alert (Optional)

An audible alert will be heard if the product's door remains open for 1 minute. The audible alert will stop when the door is closed or any button on the display (if available) is pressed.

Interior light

Interior light uses a LED type lamp. Contact the nearest Defy call centre for any problems with this lamp.

Chiller compartment (Optional)

Chiller compartments allow you to prepare the food for freezing. You can also use these compartments to store your food at a temperature a few degrees below the fridge compartment.

You can increase the inner volume of your refrigerator by removing any of the chiller compartments:

1. Pull the compartment towards yourself until it stops.
2. Lift the compartment about 1 cm up and pull towards yourself to remove it from its seating.

Crisper

Crisper of the refrigerator is designed specially to keep the vegetables fresh without losing their humidity. For this purpose, cool air circulation is intensified around the crisper in general. Remove the door shelves that stand against the crisper before removing the crisper.



Humidity-controlled crisper

Humidity rates of fruits and vegetables are kept under control thanks to the humidity-controlled crisper and thus the food is ensured to stay fresh for a longer period. We recommend that you place leafy vegetables such as lettuce and spinach and vegetables sensitive to humidity loss as horizontally as possible when putting them in the crisper; not in a horizontal position on their roots.

While the vegetables are being replaced, their specific weights should be taken into consideration. Heavy and hard vegetables must be placed at the bottom of the crisper and light and soft vegetables must be on the upper part.

Never leave the vegetables in their plastic bags in the crisper. If they are left in their plastic bags, this will cause them to rot in a little while. If you not prefer the vegetable to get in contact with other vegetables for hygienic reasons, use perforated paper or a similar material instead of plastic bags.

Using the product

Do not place pears, apricots, peaches etc., especially those fruits that generate large amounts of ethylene, in the same crisper with other fruits and vegetables. The ethylene gas emitted by these fruits cause other fruits to ripen sooner and to rot in a shorter span of time.

Egg tray

You can install the egg holder to the desired door or body shelf.

Never keep the egg holder in the freezer compartment.

Movable Middle Section

Movable middle section is intended to prevent the cold air inside your refrigerator from escaping outside.

1- Sealing is provided when the gaskets on the door presses on the surface of the movable middle section while the fridge compartment doors are closed.

2- Another reason that your refrigerator is equipped with a movable middle section is that it increases the net volume of the fridge compartment. Standard middle sections occupy some non-usable volume in the refrigerator.

3-Movable middle section is closed when the left door of the fridge compartment is opened.

4-It must not be opened manually. It moves under the guidance of the plastic part on the body while the door is closed. Some condensation may form on middle section, side walls and doors of fridge when all doors are not opened for more than 24 hours. It will disappear after any of the doors are opened.

The front surface may feel warm. This is normal.

Cool Control Storage Compartment

The Cool Control Storage Compartment of your refrigerator may be used in any desired mode by adjusting it to fridge (2/4/6/8 °C) or freezer (-18/-20/-22/-24) temperatures. You can keep the compartment at the desired temperature with the Cool Control Storage Compartment's Temperature Setting Button.

The temperature of the Cool Control Storage Compartment may be set to 0 and 10 degrees in addition to the fridge compartment temperatures and to -6 degrees in addition to the freezer compartment temperatures. 0 degree is used to store the deli products longer, and -6 degrees is used to keep meats up to 2 weeks in an easily sliceable condition. The feature of switching to a Fridge or Freezer compartment is provided by a cooling element located in the closed section (Compressor Compartment) behind the refrigerator. During operation of this element, a clicking sound may be heard. This is normal and is not a fault.

Blue light (Optional)

A crisper illuminated with a blue light help foods stored in the crisper continue photosynthesis by means of the wavelength effect of blue light and help preserve freshness and increase vitamin content.

Odour filter (Optional)

The odour filter in the air duct of the fridge compartment prevents build-up of unpleasant odours in the refrigerator.

Ionizer (Optional)

An ionizer system in a cooler compartment's air duct serves to ionize the air. The negative ion emissions will eliminate bacteria and other odour causing molecules in the air.

Icebox and icebox drawer (Optional)

- Fill the icebox with water and put in place. The ice will be ready after approximately two hours. Do not remove the icebox to take ice.
- Turn the buttons on the ice chambers right hand side by 90°; the ice will fall to the ice storage box below. You may then remove the ice storage box and serve the ice.



The ice storage box is intended for storing ice only. Do not fill with water. Doing so will cause it to break.

6 Maintenance and Cleaning

Cleaning the product regularly will prolong its service life.



WARNING: Disconnect the power before cleaning the refrigerator.

- Do not use sharp and abrasive tools, soap, house cleaning materials, detergents, gas, gasoline, varnish and similar substances for cleaning.
- Melt a teaspoonful of carbonate in the water. Moisten a piece of cloth in the water and wring out. Wipe the device with this cloth and dry off thoroughly.
- Take care to keep water away from the lamp's cover and other electrical parts.
- Clean the door using a wet cloth. Remove all items inside before detaching the door and chassis shelves. Lift the door shelves up to detach. Clean and dry the shelves, then attach back in place by sliding in from above.
- Do not use chloric water or cleaning products on the exterior surface and chrome-coated parts of the product. Chlorine will cause rust on such metallic surfaces.
- Do not use sharp, abrasive tools, soap, household cleaning agents, detergents, kerosene, fuel oil, varnish etc. to prevent removal and deformation of the prints on plastic parts. Use lukewarm water and a soft cloth for cleaning and then wipe it dry.

Preventing bad odour

The product is manufactured free of any odorous materials. However, keeping the food in inappropriate sections and improper cleaning of internal surfaces may lead to malodour.

To avoid this, clean the inside with carbonated water every 15 days.

- Keep the foods in sealed holders. Microorganisms may spread out of unsealed food items and cause malodour.
- Do not keep expired and spoilt foods in the refrigerator.

Protecting plastic surfaces

Oil spilled on plastic surfaces may damage the surface and must be cleaned immediately with warm water.



IMPORTANT: Check the trouble shooting list on the following page before contacting the customer care line. Doing so will save you time and money. This list includes frequent complaints that are not related to faulty workmanship or materials. Certain features mentioned herein may not apply to your product.

7 Troubleshooting

The refrigerator is not working.

- The power plug is not fully settled. >>> *Plug it in to settle completely into the socket.*
- The fuse connected to the socket powering the product or the main fuse is blown. >>> *Check the fuses.*

Condensation on the side wall of the cooler compartment (MULTI ZONE, COOL, CONTROL and FLEXI ZONE).

- The environment is too cold. >>> *Do not install the product in environments with temperatures below -5°C.*
- The door is opened too frequently >>> *Take care not to open the product's door too frequently.*
- The environment is too humid. >>> *Do not install the product in humid environments.*
- Foods containing liquids are kept in unsealed holders. >>> *Keep the foods containing liquids in sealed holders.*
- The product's door is left open. >>> *Do not keep the product's door open for long periods.*
- The thermostat is set to too low a temperature. >>> *Set the thermostat to an appropriate temperature.*

Compressor is not working

- In case of sudden power failure or pulling the power plug off and putting back on, the gas pressure in the product's cooling system is not balanced, which triggers the compressor thermic safeguard. The product will restart after approximately 6 minutes. If the product does not restart after this period, contact service.
- Defrosting is active. >>> *This is normal for a fully automatic defrosting product. The defrosting is carried out periodically.*
- The product is not plugged in. >>> *Make sure the power cord is plugged in.*
- The temperature setting is incorrect. >>> *Select the appropriate temperature setting.*
- There is a power outage. >>> *The product will continue to operate normally once the power is restored.*

The refrigerator's operating noise is increasing while in use.

- The product's operating performance may vary depending on the ambient temperature variations. This is normal and not a malfunction.

The refrigerator runs too often or for too long.

- The new product may be larger than the previous one. Larger products will run for longer periods.
- The room temperature may be high. >>> *The product will normally run for long periods in a higher room temperature.*
- The product may have been recently plugged in or a new food item is placed inside. >>> *The product will take longer to reach the set temperature when recently plugged in or a new food item is placed inside. This is normal.*
- Large quantities of hot food may have been recently placed into the product. >>> *Do not place hot food into the product.*
- The doors were opened frequently or kept open for long periods. >>> *The warm air moving inside will cause the product to run longer. Do not open the doors too frequently.*
- The freezer or cooler door may be ajar. >>> *Check that the doors are fully closed.*
- The product may be set to too low a temperature. >>> *Set the temperature to a higher degree and wait for the product to reach the adjusted temperature.*
- The cooler or freezer door gasket may be dirty, worn out, broken or not properly settled. >>> *Clean or replace the gasket. A damaged / torn door gasket will cause the product to run for longer periods in order to maintain the current temperature.*

Troubleshooting

The freezer temperature is very low, but the cooler temperature is adequate.

- The freezer compartment temperature is set to a very low degree. >>> *Set the freezer compartment temperature to a higher degree and check again.*

The cooler temperature is very low, but the freezer temperature is adequate.

- The cooler compartment temperature is set to a very low degree. >>> *Set the cooler compartment temperature to a higher degree and check again.*

The food items kept in cooler compartment drawers are frozen.

- The cooler compartment temperature is set to a very low degree. >>> *Set the freezer compartment temperature to a higher degree and check again.*

The temperature in the cooler or the freezer is too high.

- The cooler compartment temperature is set to a very high degree. >>> *The cooler compartment temperature setting influences the freezer compartment temperature. Change the cooler or freezer compartment's temperature and wait until the relevant compartments reach the adjusted temperature level.*
- The doors were opened frequently or kept open for long periods. >>> *Do not open the doors too frequently.*
- The door may be ajar. >>> *Fully close the door.*
- The product may have been recently plugged in or a new food item is placed inside. >>> *This is normal. The product will take longer to reach the set temperature when recently plugged in or a new food item is placed inside.*
- Large quantities of hot food may have been recently placed into the product. >>> *Do not place hot foods into the product.*

Shaking or noise.

- The ground is not level or durable. >>> *If the product is shaking when moved slowly, adjust the feet to balance the product. Also make sure the ground is sufficiently durable to bear the product.*
- Any items placed on the product may cause noise. >>> *Remove any items placed on the product.*

The product is making noise of liquid flowing, spraying etc.

- The product's operating principles involve liquid and gas flow. >>> *This is normal and not a malfunction.*

There is sound of wind blowing coming from the product.

- The product uses a fan for the cooling process. This is normal and not a malfunction.

There is condensation on the product's internal walls.

- Hot or humid weather will increase icing and condensation. This is normal and not a malfunction.
- The doors were opened frequently or kept open for long periods. >>> *Do not open the doors too frequently; if open, close the door.*
- The door may be ajar. >>> *Fully close the door.*

There is condensation on the product's exterior or between the doors.

- The ambient weather may be humid, this is quite normal in humid weather. >>> *The condensation will dissipate when the humidity is reduced.*

Troubleshooting

The interior smells bad.

- The product is not cleaned regularly. >>> *Clean the interior regularly using a sponge, warm water and carbonated water.*
- Certain holders and packaging materials may cause odour. >>> *Use holders and packaging materials free of odour.*
- Foods were placed in unsealed holders. >>> *Keep food in sealed holders. Microorganisms may spread out of unsealed food items and cause malodour.*
- Remove any expired or spoilt foods from the product.

The door is not closing.

- Food packages may be blocking the door. >>> *Relocate any items blocking the doors.*
- The product is not standing in the full upright position on the ground. >>> *Adjust the feet to balance the product.*
- The ground is not level or durable. >>> *Make sure the ground is level and sufficiently durable to bear the product.*

The vegetable bin is jammed.

- Food items may be in contact with the upper section of the drawer. >>> *Reorganize the food items in the drawer.*

If The Surface Of The Product Is Hot.

- High temperatures may be observed between the two doors, on the side panels and at the rear grill while the product is operating. This is normal and does not require service maintenance! Be careful when touching these areas.



Warning: If you cannot eliminate the problem although you follow the instructions in this section, contact the nearest Defy service centre. Never try to repair a non-functional refrigerator yourself.



Warning: Never dispose of the Refrigerator in a fire.



Do not dispose of your Refrigerator along with regular household waste.

Contact your local authority for disposal information and facilities available.

Please register your product at
www.defy.co.za
 DEFY APPLIANCES (PTY) LTD
 P.O.BOX 12004
 JACOBS
 DURBAN
 4026
 SOUTH AFRICA

Record in the space below the listed information for future reference.

SERIAL NUMBER.....

DATE OF PURCHASE.....

PURCHASED FROM.....

.....

8 Branches

If you have followed the instructions and still have a problem, contact the customer care line on 086 100 3339. They will be able to advise you on any aspect of the product or send a qualified technician to repair it.

South African Branches:

BLOEMFONTEIN

Unit Number 5
Monument Business Park
50 Monument Road
Oranjesig, Bloemfontein
Bloemfontein.Service@defy.co.za

CAPE TOWN

5A Marconi Rd. Montague Gardens, 7441
CapeTown.Service@defy.co.za

DURBAN

135 Teakwood Road, Jacobs,
Durban, 4052
Durban.Service@defy.co.za

EAST LONDON

Robbie de Lange Road, Wilsonia,
East London, 5201
EastLondon.Service@defy.co.za

GAUTENG, MIDRAND

127 15th Road, Cnr Pharmaceutical & 15th Rd,
Midrand, Gauteng
Gauteng.Service@defy.co.za

POLOKWANE

87 Nelson Mandela Drive, Superbia 0699
Polokwane.Service@defy.co.za

PORT ELIZABETH

112 Patterson Road, North End, Port Elizabeth
6001
PortElizabeth.Service@defy.co.za

Sub-Saharan Africa Branches:

ZAMBIA: SOUTHGATE INVESTMENTS LTD

Plot 1606, Sheki Sheki Road
P.O. Box 33681
Lusaka, 10101, Zambia
Tel: +260 0211 242332/3
Fax: +260 0211 242933
sgiservicecentre@microlink.zm

NAMIBIA: ATLANTIC DISTRIBUTORS (PTY) LTD

10 Tienie Louw Street, Northern Industrial Area
P.O. Box 21158, Windhoek, Namibia
Tel: (061) 216162
Fax: (061) 216134
atlantic@mweb.com.na

ZIMBABWE: TRADECOMAFRICA

Trade Com Africa, 183 Loreley Crescent
Msasa, Harare, Zimbabwe
Tel: +263 4 486165/6
Cell: +263 772 469010
Cell: +263 772 469011

BOTSWANA: RAY MORGAN AGENCIES

RMA Service Centre, Plot 48, East Gate
Gaborone International Commerce Park
Kgale View, Gaborone
Botswana
Tel: +267 390 3996 / 390 3912
Fax: +267 318 7376
Cell: +267 7134 6539
service@rma.co.bw; raja@rma.co.bw

SWAZILAND: LYNDS DISTRIBUTORS

P.O Box 716, Mbabane, Swaziland, H100
Tel: (00268) 2515 4310/8
Fax: (00268) 2518 4318

MOZAMBIQUE: COOL WORLD. LDA

Rua da Resistencia No. 97B R/C
Cell: +258 84 44 61 234
coolworldlda@hotmail.com
Nosso Show Room
Av: da Industrias, Parcela No.735 * 735A
Machava, Maputo

9 Warranty

This certificate is issued by DEFY APPLIANCES LIMITED manufacturers of Defy and Ocean products, hereinafter the Company, to the original purchaser only, of the appliance described on the certificate and shall constitute the only warranty given in respect of this appliance.

The Company warrants to the original purchaser that for a period of *THREE YEARS from date of purchase, plus an additional *TWO years on registration, the appliance is free from defect under normal domestic use, both in workmanship and material, subject to the following conditions.

1. Repair or replacement of any part of this appliance, found by the Company to be defective, shall be at the election of the Company. The Company reserves the right to effect such service through any of its Service Divisions or Authorised Service Dealers. The cost of such service shall be borne by the Company in full, provided that the appliance is located no further than 50km from a Company Service Centre or an Authorised Service Dealer. Where the appliance is located beyond the 50km radius, the purchaser shall be liable for the standard travelling charges, as determined by the Company.
2. Vitreous enamelware, fuses and lamps are specifically excluded from these warranties. It is an express condition of these warranties that the purchaser takes due care and attention in the use and maintenance of the appliance. Abuse, misuse in conflict with operating instructions, connection to incorrect voltages and subsection to commercial use shall release the Company from its obligations.
3. This warranty shall become void and cease to operate if the appliance is dismantled by, or any repairs to the appliance are effected by any persons not duly authorised by the Company, or if substitute parts not approved by the Company are used in the appliance, or if the serial number of the appliance is removed.
4. The Company shall not be responsible for damages resulting from fire, flood, civil disturbances or any Act of God. The Company shall not, in terms of these warranties be responsible nor held liable for any consequential loss or damage of any kind caused by or due to the failure or malfunction of the appliance. The Company shall not be responsible for damages caused by insect and/or animal infestation.
5. The Company shall not be responsible for transportation or other costs other than those incurred within the provisions of Point 1 of this Certificate.
6. **For warranties in the Republic of South Africa and Sub-Saharan Africa, please contact the customer care line. Please refer to the previous page for respective South African branches and Sub-Saharan Africa branches.**
7. Where service is requested under warranty and no fault or defect can be found by the Company, all costs incurred will be for the purchaser's account.
8. This Certificate as well as your invoice will serve as proof of purchase. For the purpose of warranty, it will be essential to produce this Certificate and invoice. Failure to do so, will render the purchaser liable for service costs.

KEEP THIS CERTIFICATE AND SALES INVOICE AS PROOF OF PURCHASE FOR WARRANTY PURPOSES.

*THREE YEARS full coverage, additional *TWO YEARS (with registration) will cover only parts, labour cost to be charged accordingly. Please register your product at www.defy.co.za in order to activate the additional two year warranty.