

**F740-F790**  
**SBS REFRIGERATORS**



Believe in better



**Customer Care Line**  
(after sales service)

**086 100 3339**

**Part number: 3810190100 AK**



**Refrigeration**  
Instruction manual

## Read this manual before initial installation and operation of the refrigerator!

Dear Customer,

Your new Defy refrigerator was manufactured in a state of the art facility and has passed the strictest quality control procedures.

Please read this manual carefully before using your product for the first time and then store it within easy reach for future reference.

We trust you will enjoy years of trouble free use.

### The user manual:

- This manual will provide you with information on how to safely operate and care for your refrigerator in order that you gain the maximum benefit from it.
- Pay particular attention to any safety instructions.
- Please read all additional documents supplied with your product.
- Please note that this manual may be used for several similar but different models. Please check for relevance regarding your particular model.

### Explanation of symbols used in this manual

 Important safety information. Warning for hazardous situations with regard to life and property.

 Caution; Warning for supply voltage.

 Caution; Warning for fire hazard.

 Useful information. Important information or useful hints about usage.

	<b>Unpacking:</b> Remove all packaging. Ensure that packing material is disposed of in a responsible manner and that any plastic bags are cut up to prevent children playing with them and accidentally suffocating.
	If the refrigerator is damaged in any way do not use it. Report the damage to your dealer who will take the necessary corrective action.

# Contents

---

<b>1 Important safety information</b>	<b>4</b>	<b>4 Preparation</b>	<b>14</b>
Warnings	4	Things to be done for energy saving	14
For models with water fountain	4	First use	15
Child safety	6	<b>5 Using the product</b>	<b>15</b>
HCA warning	6	Indicator panel	15
<b>2 Your Refrigerator</b>	<b>7</b>	Activating the water filter replacement alert	21
<b>3 Installation</b>	<b>8</b>	Using the water dispenser	24
Installation location	8	Cleaning the water tank	25
Attaching the plastic wedges	8	Dispensing Ice / water	26
Adjusting the feet	9	Drip tray	26
Power connection	9	Zero degree compartment	27
Water connection	9	Vegetable bin	27
Connecting water hose to the product	10	Blue light	27
Connecting to water mains	10	Ionizer	27
Water filter	12	Minibar	27
Fixing external filter to the wall	12	Odour filter	27
Internal filter	13	Icematic and ice storage container	27
Water line	13	Ice-maker	27
Carboy line	13	Freezing fresh food	28
		Recommendations for storing frozen foods	28
		Deep freezer details	28
		Placing food	28
		Door open alert	29
		Interior light	29
		<b>6 Maintenance and cleaning</b>	<b>29</b>
		Preventing malodour	29
		Protecting plastic surfaces	29
		<b>7 Troubleshooting</b>	<b>30</b>
		<b>8 Branches</b>	<b>33</b>
		<b>9 Warranty</b>	<b>34</b>

## **1 Important safety information**

Please review and observe the following information. Failure to do so may result in injuries or material damage and will render any warranty and reliability commitments void.

### **Warnings**

- The refrigerator must only be used for its intended purpose, i.e. storing of edible foodstuff.
- The refrigerator is intended to be used in household and similar applications such as staff kitchen areas in shops, offices and other working environments; farm houses and by clients in hotels, motels and other residential type environments; bed and breakfast type environments; catering and similar non-retail applications.
- This appliance is not intended for use by persons (including children) with reduced physical, sensory or mental capabilities, or lack of experience and knowledge, unless they have been given supervision or instruction concerning use of the appliance by a person responsible for their safety.
- Children should be supervised to ensure that they do not play with the appliance.
- In the event of a malfunction, disconnect the refrigerator from the power supply.
- Vapour and vaporized cleaning materials must never be used in the cleaning the refrigerator. The vapour may come into contact with the electrical parts and cause a short circuit or electric shock.
- Do not allow children to hang on the refrigerator doors as the unit could topple forward risking personal injury. Never use the parts on your refrigerator, such as the door, as a means of support or step.
- Keep ventilation openings, in the appliance enclosure or in the built-in structure, clear of obstruction.
- Do not use electrical appliances inside the food storage compartments of the appliance, unless they are of the type recommended by the manufacturer.
- Unplug the refrigerator when cleaning, during routine maintenance or if it will not be used for an extended period.
- To unplug the refrigerator, remove the plug by pulling on the plug and not the cable!
- Never connect your refrigerator to electricity saving systems as they may damage the refrigerator.

### **For models with water fountain**

- Water supply pressure must be minimum 1 bar and maximum 8 bars.
- Use drinking water only.

- If the supply cord is damaged, it must be replaced by the manufacturer, its service agent or similarly qualified persons in order to avoid a hazard.
- Exposing the refrigerator to rain, snow, sun and wind is an electrical safety risk.
- Do not store medicine or academic research samples which require strict temperature control in the refrigerator.
- Do not store or use flammable gas, benzene, petrol or volatile substances in or near the refrigerator.
- Do not store explosive substances such as aerosol cans with a flammable propellant in the refrigerator.
- Do not overload your refrigerator with large amounts of food. If overloaded, the food may fall down and injure you and damage the refrigerator when opening the door. Never place objects on top of the refrigerator, they may fall and injure you when you open or close the refrigerator door.
- The refrigerator may move if the adjustable legs are not properly levelled on the floor. Levelling the adjustable legs on the floor helps prevent the refrigerator from moving.
- If there is a blue light fitted on the refrigerator, do not look at the blue light through optics.
- When carrying the refrigerator, do not hold on the door handle as the handle may break.
- When placing your refrigerator next to another refrigerator or freezer, the distance between the devices must be at least 8 cm. Failure to do so may cause adjacent walls to humidify.
- Do not put bottled or canned liquid beverages in the freezer compartment: they may burst.
- Do not touch frozen food with your hands; it may stick to your hands.
- Never pour or spray water into or on the refrigerator and do not store liquids, pot plants or open containers on top of the refrigerator as these may spill causing electrical shorting.
- Avoid any damage to the power cable when transporting the refrigerator.
- Bending the cable may cause a fire.
- Never place heavy objects on the power cable.
- Do not touch the plug with wet hands.
- Contact a Defy service centre for all questions and problems relating to the refrigerator.
- The lamp(s) used in this appliance is not suitable for household room illumination.
- If the product has LED type lighting, contact the Defy service centre for replacing or in case of any problem.

- Do not plug in the refrigerator if the wall socket is loose.
- On delivery, check to make sure that the refrigerator is not damaged and that all the parts and accessories are in perfect condition.
- Ensure that the plug remains readily accessible. Do not use multiple adapter plugs or an extension cable.
- Ensure that there is sufficient spacing between the refrigerator and surrounding walls.





**Child safety**

- If the door has a lock, keep the key out of reach from children.
- If you are discarding an old refrigerator with a lock or latch fitted to the door, disable the lock/latch, and ensure that the refrigerator is left in a safe condition to prevent children from being trapped inside and suffocating.
- Children must be supervised to prevent them from tampering with the refrigerator.

**HCA Warning**

Refrigerator cooling systems containing R600a: This refrigerator contains non CFC/ HFC natural substances in the cooling system (Called R600a) and in the insulation (Called cyclopentane). These are potentially flammable if exposed to fire. Take care not to damage

the cooling circuit / pipes of the refrigerator in transportation and in use. In case of damage do not expose the refrigerator to fire or potential ignition sources and immediately ventilate the room where the refrigerator is situated. Ignore this warning if your refrigerators cooling system contains R134a.

	Do not drill, cut or modify the refrigerator. Injuries may result if the refrigerant circuit is damaged. <b>WARNING:</b> Do not damage the refrigerant circuit.
	Do not operate a damaged refrigerator. Contact the nearest Defy service center.
	The electrical safety of the refrigerator is only guaranteed if the earth system of your home is compliant to national standards.
	Repairs must be carried out by authorised persons only. Repairs carried out by incompetent persons create a user risk.
	Never plug the refrigerator into the wall socket during installation. Death or serious injury may result.

## 2 Your Refrigerator

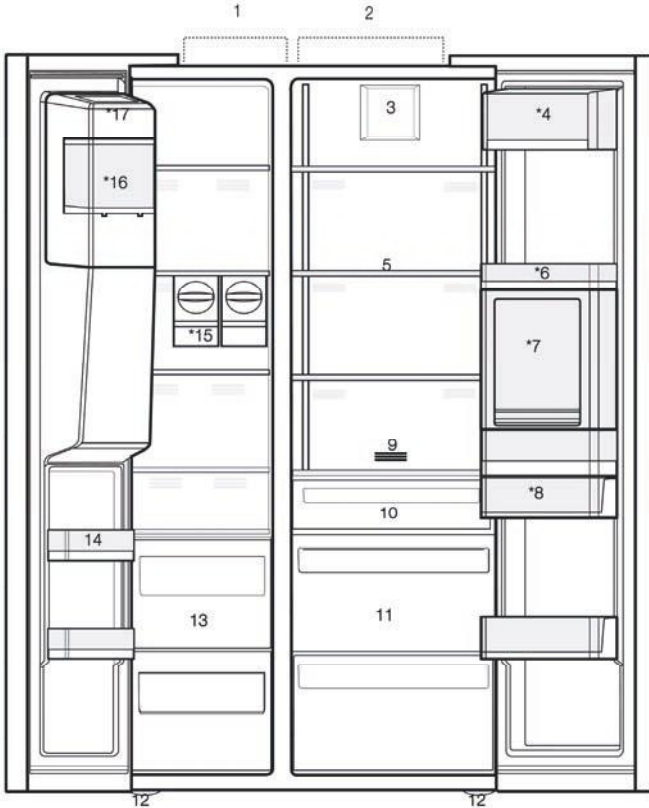

- 1- Freezer compartment
  - 2- Cooler compartment
  - 3- Fan
  - 4- Butter-cheese compartment
  - 5- Glass shelves
  - 6- Cooler compartment door shelves
  - 7- Minibar accessory
  - 8- Water tank
  - 9- Odour filter
  - 10- Zero degree compartment
  - 11- Vegetable bins
  - 12- Adjustable feet
  - 13- Frozen food storing compartments
  - 14- Freezer compartment door shelves
  - 15- Icematics
  - 16- Ice storage box
  - 17- Ice-maker decorative lid
- \*Optional**





**\*Optional:** Figures in this user guide are schematic and may not be exactly match your product. If your product does not comprise the relevant parts, the information pertains to other models.

### 3 Installation

#### Installation location

Contact the Authorized Service for the product's installation. To ready the product for installation, see the information in the user guide and make sure the electric and water utilities are as required. If not, call an electrician and plumber to arrange the utilities as necessary.

	<b>WARNING:</b> The manufacturer assumes no responsibility for any damage caused by the work carried out by unauthorized persons.
	<b>WARNING:</b> The product's power cable must be unplugged during installation. Failure to do so may result in death or serious injuries!
	<b>WARNING:</b> If the door span is too narrow for the product to pass through, remove the door and turn the product sideways; if this does not work, contact the authorized service.

- Place the product on a flat surface to avoid vibration.
- Place the product at least 30 cm away from heaters, stoves and similar sources of heat and at least 5 cm away from electric ovens.
- Do not expose the product to direct sunlight or keep in damp environments.
- The product requires adequate air circulation to function efficiently. If the product will be placed in an alcove, remember to leave at least 5 cm distance between the product and the ceiling and the walls.
- Do not install the product in environments with temperatures below -5°C.

#### Attaching the plastic wedges

Use the plastic wedges provided with the product to provide sufficient space for air circulation between the product and the wall.

1. To attach the wedges, remove the screws on the product and use the screws provided with the wedges.

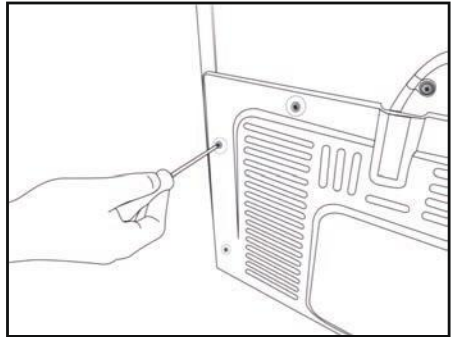

2. Attach the 2 plastic wedges on the ventilation cover shown as in the figure.

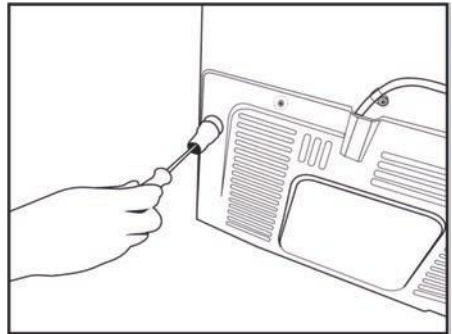



## Installation

### Adjusting the feet

- If the product is not in a balanced position, adjust the front adjustable feet by rotating right or left.

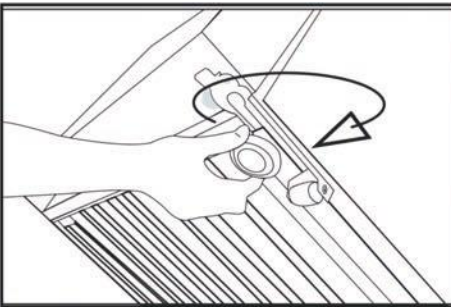
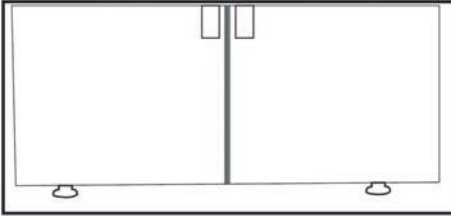

### Power connection

	<b>WARNING:</b> Do not use extension or multi sockets in the power connection.
	<b>WARNING:</b> Damaged power cable must be replaced by authorized service.
	When placing two coolers in an adjacent position, leave at least 4 cm distance between the two units.

- Our firm will not assume responsibility for any damages due to usage without earthing and power connection in compliance with national regulations.
- The power cable plug must be easily accessible after installation.
- Connect the refrigerator to an earthed socket with 220-240V/50 Hz voltage. The plug must comprise a 10-16A fuse.
- Do not use a multi-group plug with or without an extension cable between the wall socket and the refrigerator.

### Water connection (Optional)



**WARNING:** Unplug the product and the water pump (if available) during connection.

- The product's water mains, filter and carboy connections must be done by authorized service. The product can be connected to a carboy or directly to the water mains, depending on the model. To establish the connection, the water hose must first be connected to the product.
- Check to see the following parts are supplied with your product model:

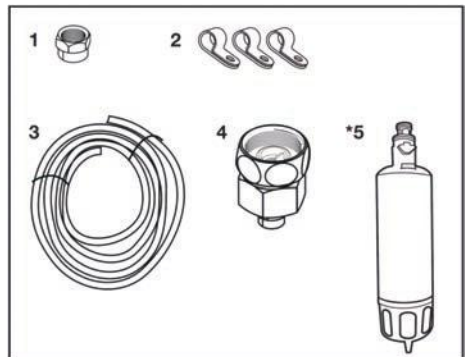

1. Connector (1 piece): Used to attach the water hose to the rear of the product.
2. Hose clip (3 pieces): Used to fix the water hose on the wall.
3. Water hose (1 piece, 5 meters, diameter 1/4 inches): Used for the water connection.
4. Faucet adapter (1 piece): Comprises of a porous filter, used for connection to the cold water mains.
5. Water filter (1 piece \*Optional): Used to connect the mains water to the product. Water filter is not required if a carboy connection is available.

## Installation

### Connecting water hose to the product

To connect the water hose to the product, follow the instructions below.

1. Remove the connector on the hose nozzle adaptor at the back of the product and run the hose through the connector.

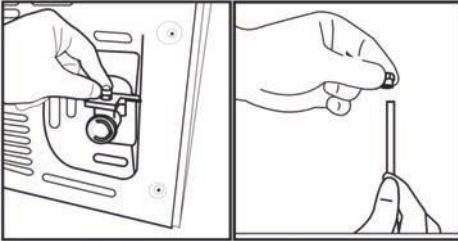

2. Push the water hose down tightly and connect to the hose nozzle adaptor.

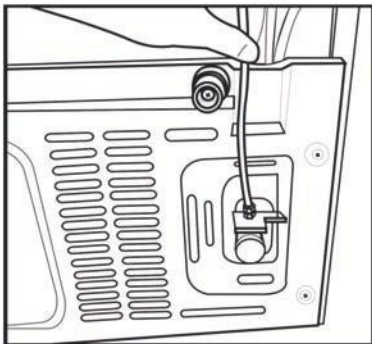

3. Tighten the connector manually to fix on the hose nozzle adaptor. You may also tighten the connector using a pipe wrench or pliers.

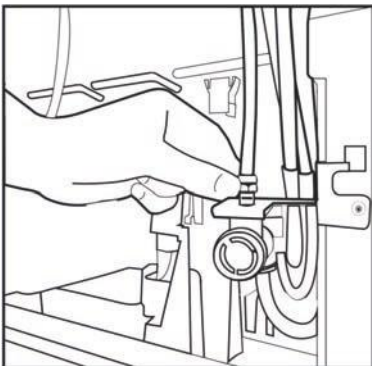

4. Connect the other end of the hose to the water mains or to the water pump. See page 11 to use a carboy.

### Connecting to water mains (Optional)

To use the product by connecting to the cold water mains, a standard 1/2" valve connector must be installed to the cold water mains in your home. If the connector is not available or if you are unsure, consult a qualified plumber.

1. Detach the connector (1) from the faucet adaptor (2).

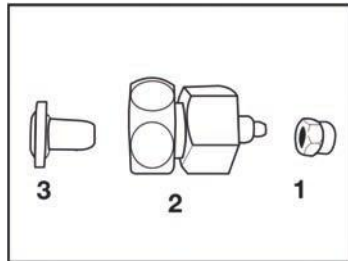

2. Connect the faucet adaptor to the water mains valve.

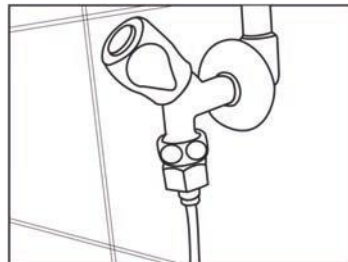

3. Attach the connector around the water hose.

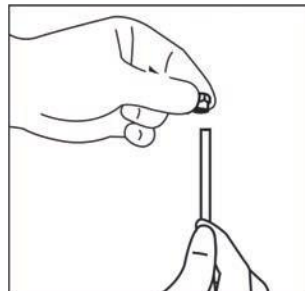

## Installation

4. Attach the connector into the faucet adaptor and tighten by hand / tool.

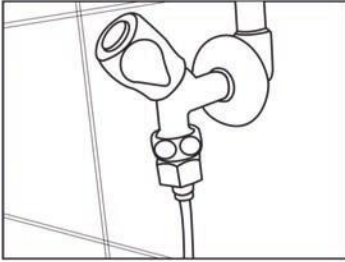

5. To avoid damaging, shifting or accidentally disconnecting the hose, use the clips provided to fix the water hose appropriately.

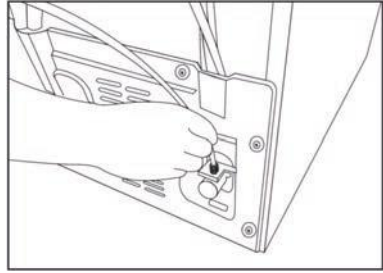
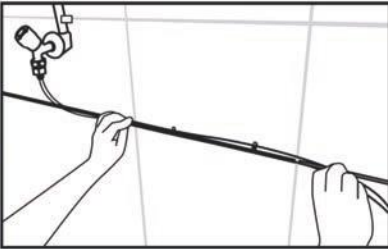

2. Connect the other end of the water hose to the water pump by pushing the hose into the pump's hose inlet.

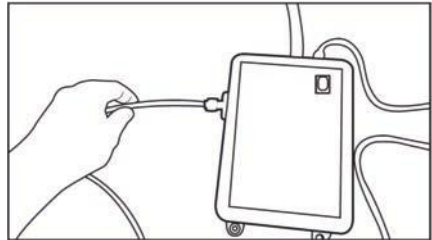

3. Place and fasten the pump hose inside the carboy.

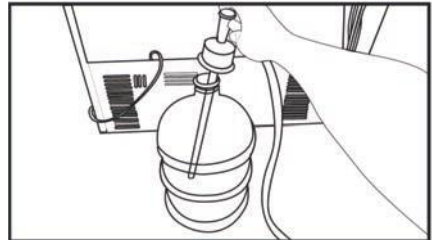

4. Once the connection is established, plug in and start the water pump.



**WARNING:** After turning the tap on, ensure there is no water leak on either end of the water hose. In case of leakage, turn the valve off and tighten all connections using a pipe wrench or pliers.

### For products using water carboy (Optional)

To use a carboy for the product's water connection, the water pump recommended by the authorized service must be used.

1. Connect one end of the water hose provided with the pump to the product and follow the instructions.



Please wait 2-3 minutes after starting the pump to achieve the desired efficiency.



Please read the pump's user guide for water connection.



When using a carboy, a water filter is not required.

## Installation

### Water filter (Optional)

The product may have an internal or external filter, depending on the model. To attach the water filter, follow the instructions below.

### Fixing external filter on the wall (Optional)



**WARNING:** Do not fix the filter on to the product

Check to see the following parts are supplied with your product model:

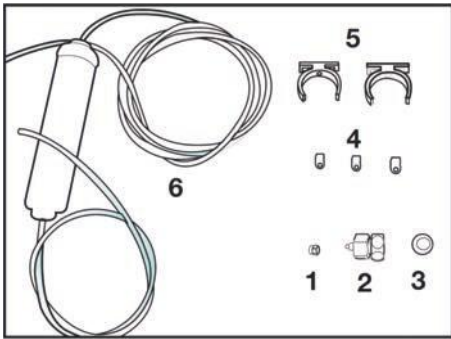

1. Connector (1 piece): Used to attach the water hose to the rear of the product.
2. Faucet adapter (1 piece): Used for connection to the cold water mains.
3. Porous filter (1 piece)
4. Hose clip (3 pieces): Used to fix the water hose on the wall.
5. Filter connecting apparatus (2 pieces): Used to fix the filter on the wall.
6. Water filter (1 piece): Used to connect the product to the water mains. A water filter is not necessary when using carboy connection.

1. Connect the faucet adaptor to the water mains valve.
2. Determine the location to fix the external filter. Fix the filter's connecting apparatus (5) on the wall.
3. Attach the filter in the upright position on the filter connecting apparatus, as indicated on the label. (6)

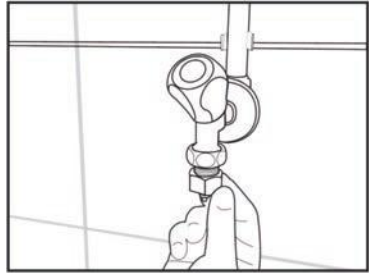

4. Attach the water hose extending from the top of the filter to the product's water connection adaptor, (see page 10).

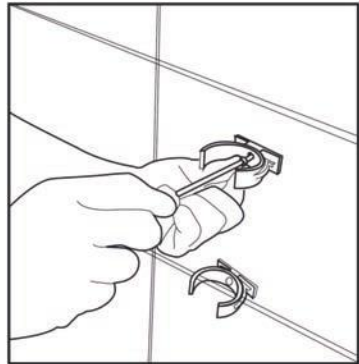

After the connection is established, it should look like the figure below.

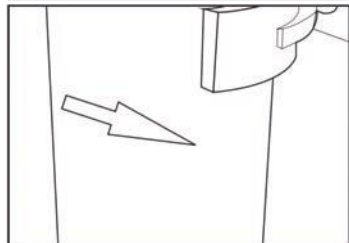
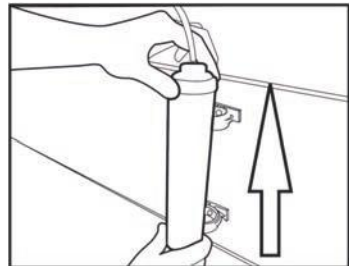

## Installation

### Internal filter

The internal filter provided with the product is not installed upon delivery; please follow the instructions below to install the filter.

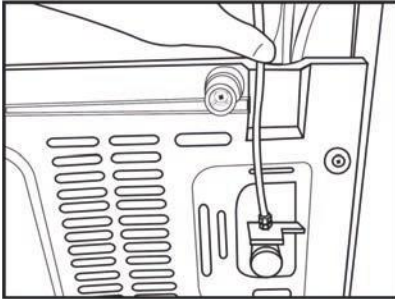

### Water line

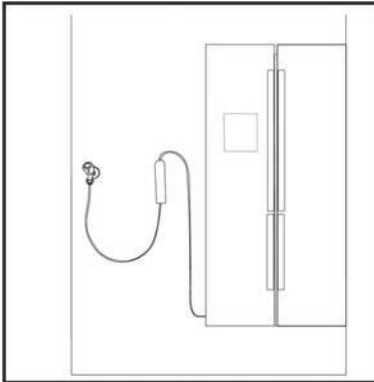

### Carboy line

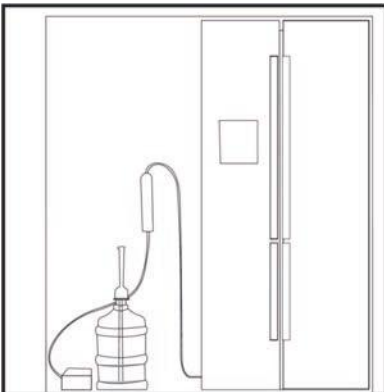

Do not use the first 10 glasses of water after connecting the filter.

1. The “Ice Off” indicator must be active while installing the filter. Switch the **ON-OFF** indicator using the “Ice” button on the screen.

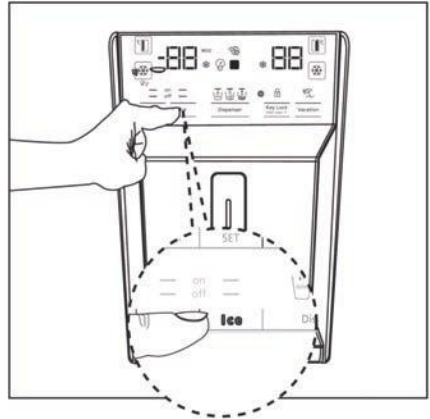

2. Remove the vegetable bin (a) to access the water filter.

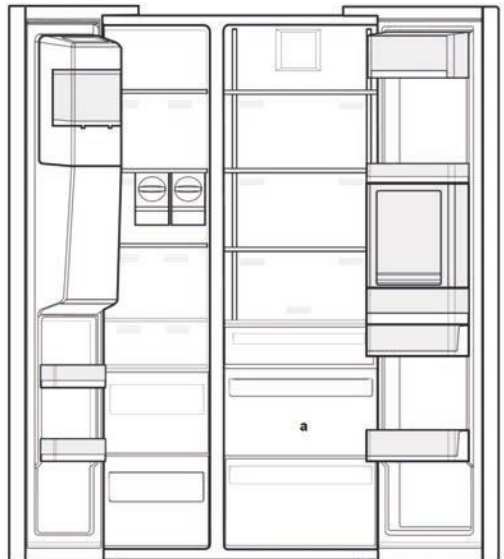

## Installation

3. Remove the water filter by-pass cover by pulling.

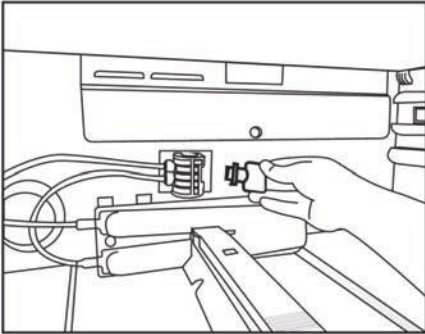

4. Place the water filter cover into the mechanism and push to lock in place.

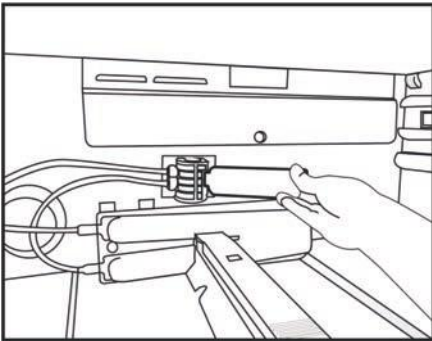

5. Push the "Ice" button on the screen again to cancel the "Ice Off" mode.



The water filter will clear certain foreign particles in the water. It will not clear microorganisms in the water.

See page 21 for activating the filter replacement period.

A few drops of water may flow out after removing the cover; this is normal.

## 4 Preparation

### Things to be done for energy saving



Connecting the product to electronic energy-saving systems is harmful, as it may damage the product.

- Do not keep the refrigerator doors open for long periods.
- Do not place hot food or beverages into the refrigerator.
- Do not overfill the refrigerator; blocking the internal air flow will reduce the cooling capacity.
- The energy consumption value specified for the refrigerator was measured with the freezer compartment's upper shelf removed, other shelves and the lowest drawers in place and under maximum load. The top glass shelf can be used, depending on the shape and size of food to be frozen.
- Depending on the product's features; defrosting frozen foods in the cooler compartment will ensure energy saving and preserve food quality.
- Make sure the foods are not in contact with the cooler compartment temperature sensor indicated below.

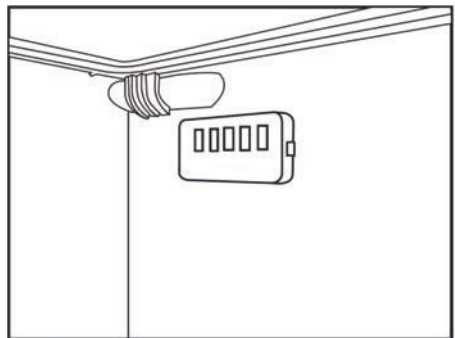



Ensure the fridge contents do not touch the back wall of the refrigerator to prevent them from freezing.

### First Use

Before using your refrigerator, make sure the necessary preparations are made in line with the instructions in “Safety and environment instructions” and “Installation” sections.

- Keep the product running with no food inside for 6 hours and do not open the door, unless absolutely necessary.

	A sound will be heard when the compressor is engaged. It is normal to hear sound even when the compressor is inactive, due to the compressed liquids and gasses in the cooling system.
	It is normal for the front edges of the refrigerator to be warm. These areas are designed to warm up in order to prevent condensation.

## 5 Using the product

### Indicator panel

Indicator panels may vary depending on the model of your product.

Audial and visual functions of the indicator panel will assist in using the refrigerator.

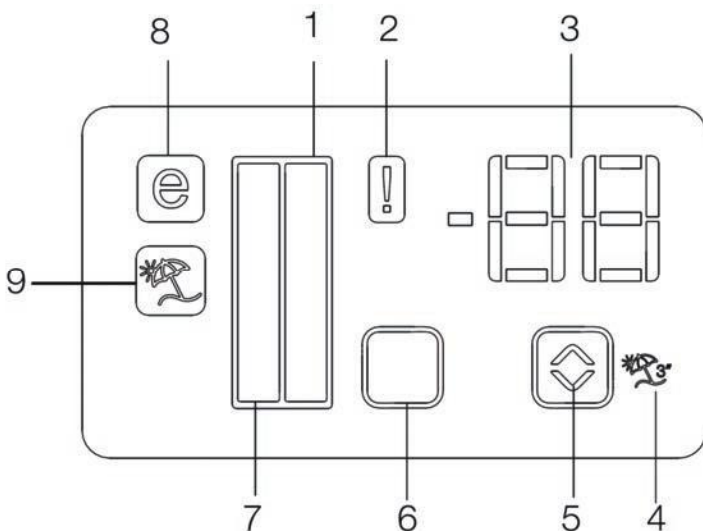

1. Cooler compartment indicator
2. Error status indicator
3. Temperature indicator
4. Vacation function button
5. Temperature adjustment button
6. Compartment selection button
7. Cooler compartment indicator
8. Economy mode indicator
9. Vacation function indicator

**\*optional**



**\* Optional:** Figures represented in this instruction manual are schematic and may not correspond exactly with your refrigerator. If the parts are not included in the refrigerator you have purchased, they may be model specific and therefore only valid for some models.

## Using the product

---

### 1. Cooler compartment indicator

The cooler compartment light will turn on when adjusting the cooler compartment temperature.

### 2. Error status indicator

This sensor will activate if the refrigerator is not cooling adequately or in case of sensor fault. When this indicator is active, the freezer compartment temperature indicator will display "E" and the cooler compartment temperature indicator will display "1, 2, 3..." etc. numbers. The numbers on the indicator serve to inform the service personnel about the fault.

### 3. Temperature indicator

Indicates the temperature of the freezer and cooler compartments.

### 4. Vacation function button

To activate this function, press and hold the Vacation button for 3 seconds. When the Vacation function is active, the cooler compartment temperature indicator displays the inscription "- -" and no cooling process will be active in the cooling compartment. This function is not suitable to keep food in the cooler compartment. Other compartments will remain cooled with the respective temperature set for each compartment.

Push the Vacation button () again to cancel this function.

### 5. Temperature adjustment button

Respective compartment's temperature varies in -24°C..... -18°C and 8°C...1°C ranges.

### 6. Compartment selection button

Use the refrigerator compartment selection button to toggle between the cooler and freezer compartments.

### 7. Cooler compartment indicator

The freezer compartment light will turn on when adjusting the cooler compartment temperature.

### 8. Economy mode indicator

Indicates the refrigerator is running on energy- saving mode. This indicator will be active when the temperature in the freezer compartment is set to -18°C.

### 9. Vacation function indicator

Indicates the vacation function is active.



## Using the product

### Indicator panel

Indicator panels may vary depending on the model of your product. Audial and visual functions of the indicator panel help assist in using the refrigerator.

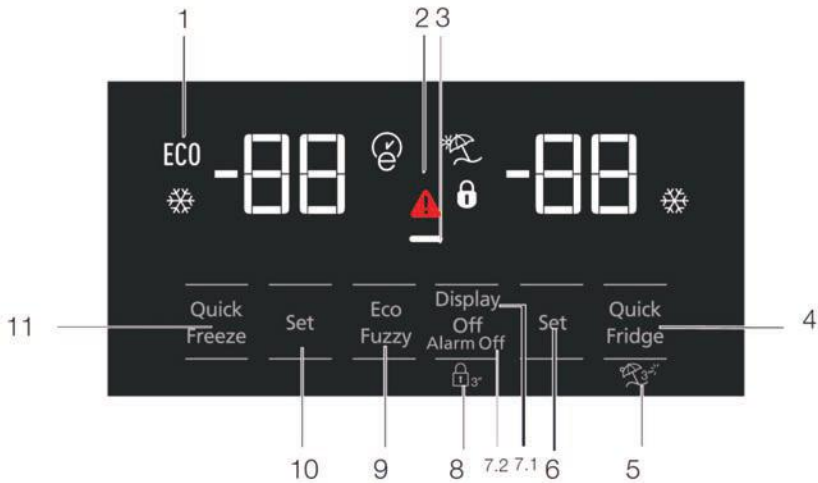

1. Economic use
- 2- High temperature / fault alert
3. Energy saving function (display off)
- 4- Rapid cooling
- 5- Vacation function
- 6- Cooler compartment temperature setting
7. Energy saving (display off) /Alarm off warning
- 8- Keypad lock
- 9- Eco-fuzzy
- 10- Freezer compartment temperature setting
- 11- Rapid freezing



**\* Optional:** Figures represented in this instruction manual are schematic and may not correspond exactly with your refrigerator. If the parts are not included in the refrigerator you have purchased, they may be model specific and therefore only valid for some models.

## Using the product

---

### 1. Economic use

This sign will light up when the freezer compartment is set to  $-18^{\circ}\text{C}$ , the most economical setting. () Economic use indicator will turn off when rapid cooling or rapid freezing function is selected.

### 2. Power failure/High temperature / error warning indicator

This indicator () will light up in case of temperature faults or fault alerts. If you see this indicator is lit up, please see the troubleshooting section in this guide. This indicator illuminates during power failure, high temperature failures and error warnings. During sustained power failures, the highest temperature that the freezer compartment reaches will flash on the digital display. After checking the food located in the freezer compartment press the alarm off button to clear the warning.

Please refer to the troubleshooting section on your manual if you observe that this indicator is illuminated.

### 3. Energy saving function (display off)

If the product doors are kept closed for a long time the energy saving function is automatically activated and the energy saving symbol is illuminated. When energy saving function is activated, all symbols on the display other than the energy saving symbol will turn off. When the Energy Saving function is activated, if any button is pressed or the door is opened, the energy saving function will be cancelled and the symbols on display will return to normal.

The energy saving function is activated from the factory and cannot be cancelled.

### 4. Rapid cooling

When the rapid cooling function is turned on, the rapid cool indicator will light up () and the cooler compartment temperature indicator will display the value 1. Push the Rapid cool button again to cancel this function. The Rapid cool indicator will turn off and return to normal setting. The rapid cooling function will be automatically cancelled after 1 hour, unless cancelled by the user. To cool a large amount of fresh food, press the rapid cool button before

placing the food in the cooler compartment.



### 5. Vacation function

To activate the Vacation function, press the quick fridge button for 3 seconds; this will activate the vacation mode indicator () . When the Vacation function is active, the cooler compartment temperature indicator displays the inscription "- -" and no cooling process will be active in the cooling compartment. This function is not suitable to keep food in the cooler compartment. Other compartments will remain cooled with the respective temperature set for each compartment. Push the vacation function button again to cancel this function.

### 6. Cooler compartment temperature setting

After pressing the button number (5), the cooler compartment temperature can be set to 8,7,6,5,4,3,2 and 1 respectively. ()

#### 7. 1 Energy saving (display off)

Pressing this button () will light up the energy-saving sign () and the Energy-saving function will activate. Activating the energy-saving function will turn off all other signs on the display. When the energy-saving function is active, pressing any button or opening the door will deactivate the energy-saving function and the display signals will return to normal. Pressing this button () again will turn off the energy-saving sign and deactivate the energy-saving function.

#### 7.2 Alarm off warning

In case of power failure/high temperature alarm. After checking the food located in the freezer compartment press the alarm off button to clear the warning.

### 8. Keypad lock

Press the display off button, simultaneously for 3 seconds. The keypad lock sign will light up and the keypad lock will be activated; the buttons will be inactive when the Keypad lock is activated. Press the Display off button again simultaneously for 3 seconds. The keypad lock sign will turn off and the keypad lock mode will be disengaged. Press the Display off button to prevent changing the refrigerator's temperature settings.

## Using the product

### 9. Eco-fuzzy

To activate the eco-fuzzy function, press and hold the eco-fuzzy button for 1 second.

When this function is active, the freezer will switch to the economic mode after at least 6 hours and the economic use indicator will light up. To deactivate the (❄️) eco-fuzzy function, press and hold the eco-fuzzy function button for 3 seconds.

The indicator will light up after 6 hours when the eco-fuzzy function is active.

### 10. Freezer compartment temperature setting

The temperature in the freezer compartment is adjustable. Pressing the button will enable the freezer compartment temperature to be set at **-18, -19, -20, -21, -22, -23 and -24**.

### 11. Rapid freezing

For rapid freezing, press the button; this will activate the rapid freezing indicator (❄️). When the rapid freezing function is turned on, the rapid freeze indicator will light up and the freezer compartment temperature indicator will display the value -27. Press the Rapid freeze button (❄️) again to cancel this function. The Rapid freeze indicator will turn off and return to normal setting. The rapid freezing function will be automatically cancelled after 24 hours, unless cancelled by the user. To freeze a large amount of fresh food, press the rapid freeze button before placing the food in the freezer compartment.

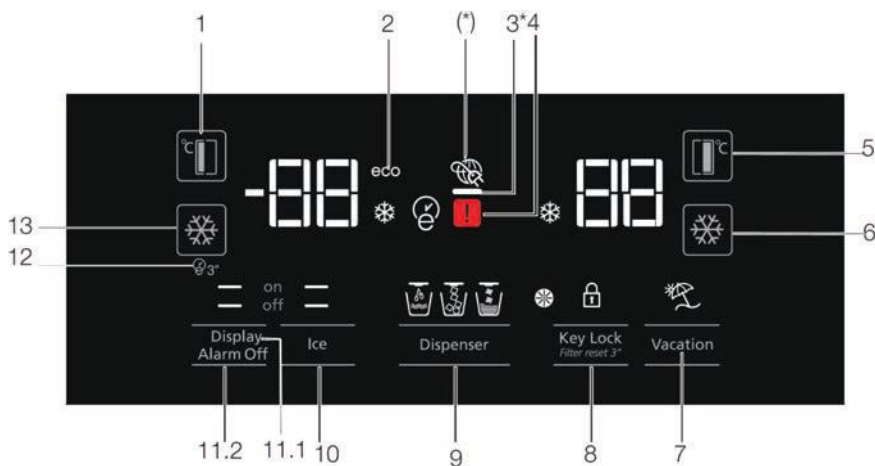

1. Freezer compartment temperature setting
2. Economy mode
3. Energy saving function (display off)
4. Power failure/High temperature / error warning indicator
5. Cooler compartment temperature setting
6. Rapid cooling
7. Vacation function
8. Keypad lock / filter replacing alert cancellation
9. Water, fragmented ice, ice cubes selection
10. Ice making on/off
11. Alarm off warning
12. Autoeco
13. Rapid freezing



**\* Optional:** Figures represented in this instruction manual are schematic and may not correspond exactly with your refrigerator. If the parts are not included in the refrigerator you have purchased, they may be model specific and therefore only valid for some models.

## Using the product

---

### 1. Freezer compartment temperature setting

Pressing the button () number (1) will enable the freezer compartment temperature to be set at -18,-19,-20,-21,-22,-23,-24,-18...

### 2. Economy mode

Indicates the refrigerator is running on energy-saving mode. This indicator will be active when the freezer compartment temperature is set at -18 or the energy-saving cooling is engaged in the eco-extra function. ()

### 3. Energy saving function (display off)

If the product doors are kept closed for a long time the energy saving function is automatically activated and the energy saving symbol is illuminated. When the energy saving function is activated, all symbols on the display other than the energy saving symbol will turn off. When the energy saving function is activated, if any button is pressed or the door is opened, the energy saving function will be cancelled and the symbols on the display will return to normal. Energy saving function is activated from the factory and cannot be cancelled.

### 4. Power failure/High temperature / error warning indicator

This indicator () will light up in case of temperature faults or fault alerts. If you see this indicator is lit up, please see the troubleshooting section in this guide.

This indicator illuminates during a power failure, high temperature failures and error warnings. During sustained power failures, the highest temperature that the freezer compartment reaches will flash on the digital display. After checking the food located in the freezer compartment press the alarm off button to clear the warning.

Please refer to the troubleshooting section in your manual if you observe that this indicator is illuminated.

### 5. Cooler compartment temperature setting

After pressing the button () number (4), the cooler compartment temperature can be set to 8,7,6,5,4,3,2.. respectively.

### 6. Rapid cooling

For rapid cooling, press the button number (5); this will activate the rapid cooling indicator () .

Press this button again to deactivate this function.



Use this function when placing fresh foods into the cooler compartment or to rapidly cool food items. When this function is activated, the refrigerator will be engaged for 1 hour.

### 7. Vacation function

When the Vacation function () is active, the cooler compartment temperature indicator displays the inscription "- -" and no cooling process will be active in the cooling compartment. This function is not suitable to keep food in the cooler compartment. Other compartments will remain cooled with the respective temperature set for each compartment.



Press the vacation function button again to cancel this function. () .

### 8. Keypad lock / Keypad lock / filter replacing alert cancellation

Press keypad lock button () to activate the keypad lock. You may also use this function to prevent changing the refrigerator's temperature settings. The refrigerator's filter must be replaced every 6 months. If you follow the instructions on page 12, the refrigerator will automatically calculate the remaining period and the filter replacing alert indicator () will light up when the filter expires.

Press and hold the button () for 3 seconds to turn off the filter alert light.

### 9. Water, fragmented ice, ice cubes selection

Navigate the water () , ice cube () and fragmented ice () selections using the button. The active indicator will remain lit.

## Using the product

### 10. Ice making on/off

Press the button (❄️) to cancel (off —) or activate (on —) ice-making.

### 11.1 Display on/off

Press the button (— off) to cancel (XX) or activate (— on) display on/off.

### 11.2 Alarm off warning

In case of power failure/high temperature alarm, after checking the food located in the freezer compartment press the alarm off button to clear the warning.

### 12. Autoeco

Press the auto eco button (e3), number, for 3 seconds to activate this function. If the door remains closed for a long time when this function is activated, the cooler section will switch to economic mode. Press the button again to deactivate this function. The indicator will light up after 6 hours when the auto eco function is active. (e)

### 13. Rapid freezing

Press the button (❄️+) for rapid freezing. Press the button again to deactivate the function.

## Activating the water filter replacement alert

### (For products connected to water mains and comprising filter)

The water filter replacement alert is adjusted as described below.

1. Press the A (Keypad lock) button while the refrigerator is operational.

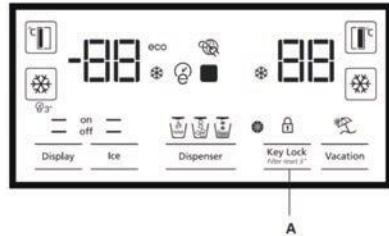

2. Then press the following buttons respectively.

1. Vacation button.
2. Cooler temperature adjustment button.
3. Rapid cool adjustment button.
4. Freezer temperature adjustment button.

If the buttons are not pressed in the respective order, the button I indicator will turn off, a short audible alert will be heard and the Filter Replacement Alert indicator will light up.

The filter service life automatic calculation function is inactive by default. This function must be activated for products comprising a filter. Your refrigerator will automatically indicate the filter replacement period after 6 months. Repeating this process when the filter service life automatic calculation is active will cancel this function.



\*Optional: The figures in this user guide are intended as drafts and may not perfectly match your product. If your product does not comprise the relevant parts, the information pertains to other models.

## Using the product

---

- 1- Power failure/High temperature / error warning
- 2- Freezer compartment temperature setting
- 3- Quick freeze
- 4- Key lock
- 5- Vacation function
- 6- Quick Fridge
- 7- Fridge compartment temperature setting
- 8- Eco fuzzy
- 9- Alarm off warning

- High temperature alarm :RED (1 Hz flash)
- Within 1 min. after the door is opened (when the door: open alarm is enabled) RED light becomes on.
- When the door is opened : WHITE
- Eco Mode : GREEN
- Quick Freeze : BLUE
- Quick Fridge : BLUE
- Vacation : YELLOW
- Display Off : GREEN
- **After the door is closed, if one of the WHITE / Eco Mode, Quick Freeze, Quick Fridge, Vacation modes are active, the colour of these modes are displayed for 1 min. (The colour of the mode is more dominant than that of the display status).**

### 1. Power failure/High temperature / error warning

This indicator illuminates during power failure, high temperature failures and error warnings. During long-term power failures, the highest temperature value that the freezer compartment reaches will blink on the digital display. After checking the food located in the freezer compartment, press the alarm off button to clear the warning. Please refer to "solutions recommended for troubleshooting" section in your manual if you observe that this indicator is illuminated.

### 2. Freezer compartment temperature setting

Temperature setting is made for freezer compartment. When this button is pressed, you can set the temperature of the freezer compartment to -18, -19, -20, -21, -22, -23 and -24.

### 3. Quick freeze

Press this button for quick freeze operation, the quick freeze indicator (❄️) will be activated.

Quick freeze indicator is lit when quick freeze function is on and fridge compartment temperature indicator displays -27. To cancel this function press the quick freeze button (❄️) again. Quick freeze indicator will turn off and refrigerator will reset to its normal settings. Quick freeze function is cancelled automatically in 24 hour if you do not cancel it. If you want to freeze large amounts of fresh food, press the quick freeze button before putting the food into the freezer compartment.

### 4. Key lock

Press and hold the alarm off button for 3 seconds. The key lock symbol will be on and key lock will be activated; When the Key Lock is on, the buttons are disabled. Press and hold the alarm off button for 3 seconds again. The key lock symbol will be off and the key lock mode will be disabled.



### 5. Vacation function

In order to activate the vacation function, press and hold the fuzzy button for 3 seconds; the vacation mode indicator (🏠) will be activated. When the vacation function is activated, "- -" is displayed on the fridge compartment temperature indicator and no active cooling operation will be performed on the fridge compartment. It is not suitable to keep the food in the fridge compartment in this function. Other compartments will continue to be cooled according to their set temperatures.

To cancel this function, press the **Vacation function** button again.

## Using the product

### Using the water dispenser (for certain models)

	The first few glasses of water taken from the dispenser will normally be warm.
	If the water dispenser is not used for a long time, dispose of the first few glasses of water to get clean water.

Please wait for approximately 12 hours for cold water after first installation. Use the display\* to select the water option (\*Using the display to select the water option depends on the model), press the trigger for water flow. Remove the glass shortly after pressing the trigger.

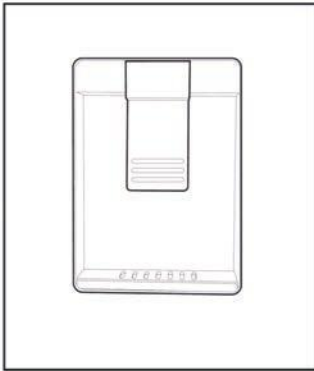

### Filling the water dispenser's tank

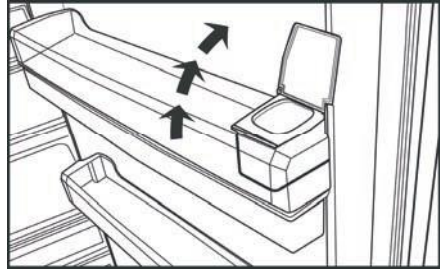
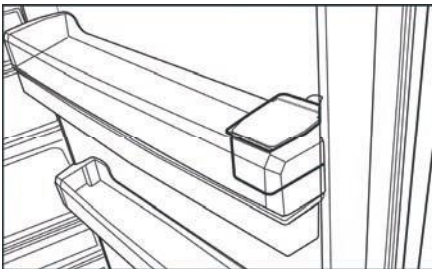

The water tank filling reservoir is located inside the door rack. Open the reservoir cover and fill up with pure and clean drinking water. Close the cover.

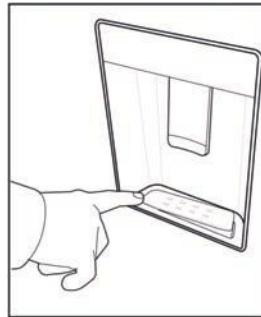

### Water tray

Any water that drips whilst using the water dispenser accumulates in the spillage tray. Remove the plastic strainer by pressing on the side as shown in the figure. With a clean and dry cloth, remove the water that has accumulated.



	Do not fill the water tank with fruit juice, fizzy beverages, alcoholic beverages or any other liquids incompatible for use in the water dispenser. Using such liquids will cause malfunction and irreparable damage to the water dispenser. Using the dispenser in this way is not covered by the warranty. Certain chemicals and additives in the beverages / liquids may cause material damage to the water tank.
	The water tank and water dispenser components cannot be washed with dishwashers.



## Using the product

### Cleaning the water tank

- Remove the water filling reservoir inside the door rack.

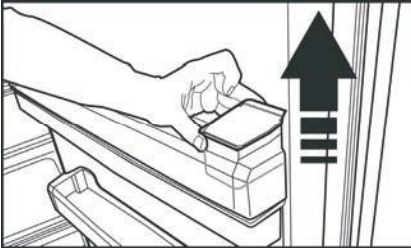

- Remove the water dispenser shelf by holding from both sides.

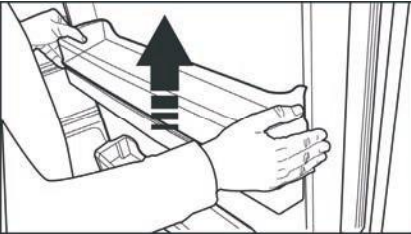

- Grab the water dispenser reservoir on both sides & remove it at an angle of 45°.

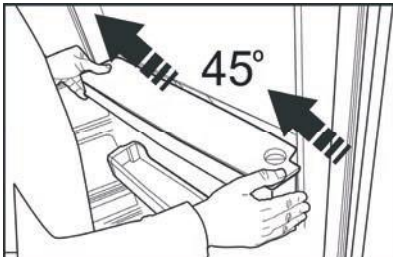

- Clean the reservoir by removing its lid.

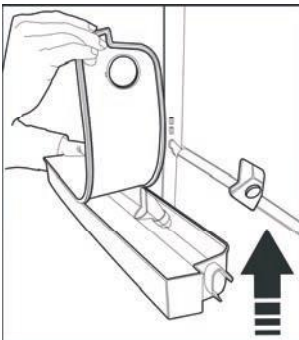



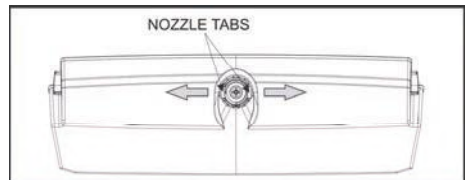

Make sure that the parts and seals removed (if any) as illustrated in the exploded diagram below, during cleaning are properly refitted to prevent any water leakage.



When fastening the nozzle, please ensure that the nozzle tabs are horizontally aligned with the dispenser housing.

## Using the product

### Dispensing ice / water (Optional)

To take water (  ) / ice cube (  ) / fragmented ice (  ), use the display to select the respective option. Take water/ice by pushing the trigger on the water dispenser forward. When switching between ice cube (  ) / fragmented ice (  ) options, the previous ice type may be discharged a few more times.

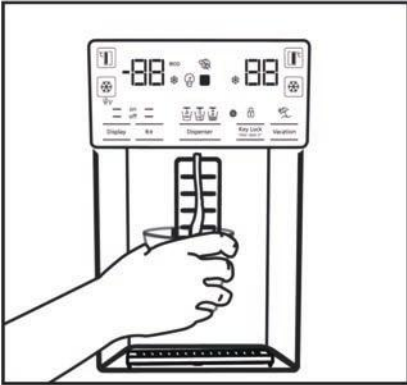

- Wait approximately 12 hours before taking ice from the ice / water dispenser for the first time. The dispenser may not discharge ice if there is insufficient ice in the ice box.
- The 30 pieces of ice cubes (3-4 Litres) taken after first operating should not be used.
- In case of power blackout or temporary malfunction, the ice may partly melt and refreeze. This will cause the ice pieces to merge with each other. In case of extended power blackouts or malfunction, the ice may melt and leak out. If you experience this problem, remove the ice in the ice box and clean the box.

 **WARNING:** The product's water system should be connected to a cold water line only. Do not connect to a hot water line.

- The product may not discharge water during first operation. This is caused by the air in the system. The air in the system must be discharged. To do this, push the water dispenser trigger for 1-2 minutes until the dispenser discharges water. The initial water flow may be irregular. The water will flow normally once the air in the system is discharged.
- The water may be cloudy during first use of the filter; do not consume the first 10 glasses of water.
- Please wait approximately 12 hours for cold water after first installation.
- The product's water system is designed for clean water only. Do not use any other beverages.
- It is recommended to disconnect the water supply if the product will not be used for long periods during vacation etc.
- If the water dispenser is not used for a long time, the first 1-2 glasses of water received may be warm.

### Drip tray (optional)

The water dripping from the water dispenser accumulates on the drip tray; no water drainage is available. Pull the drip tray out or push on the edges to remove the tray. You may then discharge the water inside the drip tray.

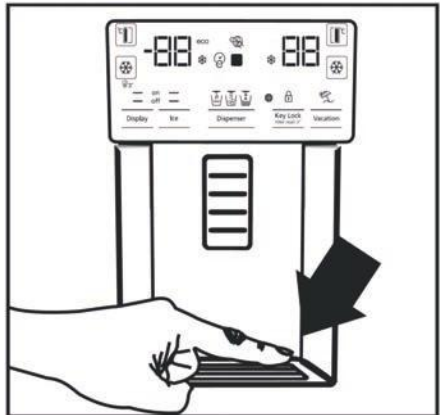

## Using the product

### Zero degree compartment (Optional)

- Use this compartment to keep delicatessen at lower temperatures or meat products for immediate consumption. Do not place fruits and vegetables in this compartment. You can expand the product's internal volume by removing any of the zero degree compartments. To remove the compartment, simply pull forth, lift up and pull out.

### Vegetable bin

- The refrigerator's vegetable bin is designed to keep vegetables fresh by preserving humidity. For this purpose, the overall cold air circulation is intensified in the vegetable bin. Keep fruits and vegetables in this compartment. Keep the green-leaved vegetables and fruits separately to prolong their life.

### Blue light (Optional)

- The product's vegetable bins comprise blue light. The vegetables in the bin will continue to photosynthesize under the blue light's wavelength effect and remain live and fresh.

### Ionizer (Optional)

- The ionizer system in the cooler compartment's air duct serves to ionize the air. The negative ion emissions will eliminate bacteria and other odour causing molecules in the air.

### Minibar (Optional)

- The refrigerator's minibar door shelf can be accessed without opening the door. This will allow you to easily take frequently consumed food and beverages from the refrigerator. To open the minibar cover, push with your hand and pull towards yourself.



**WARNING:** Do not sit, hang or place heavy objects on the minibar cover. This may damage the product or cause you to be injured.

To close this compartment, simply push forward from the upper section of the cover.

### Odour filter (optional)

The odour filter in the cooler compartment's air duct will prevent undesirable odour formation.

### Icematic and ice storage container (Optional)

- Fill the icematic with water and put in place. The ice will be ready after approximately two hours. Do not remove the icematic to take ice.
- Turn the buttons on the ice chambers right hand side by 90°; the ice will fall to the ice storage box below. You may then remove the ice storage box and serve the ice.



The ice storage box is intended for storing ice only. Do not fill with water. Doing so will cause it to break.

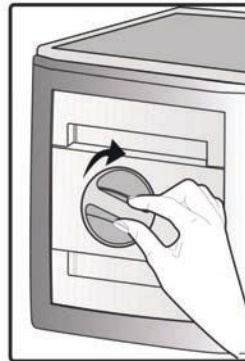

### Ice-maker (Optional)

- The ice maker is located on the upper section of the freezer cover.
- Hold the handles on the sides of the ice stock reservoir and move up to remove.
- Remove the ice-maker decorative lid by moving up.

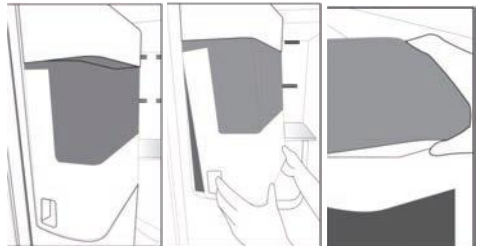

## Using the product

### Freezing fresh food

- To preserve food quality, the food items placed in the freezer compartment must be frozen as quickly as possible, use the rapid freezing for this.
- Freezing food items when fresh will extend the storage time in the freezer compartment.
- Pack the food items in air-tight packs and seal tightly.
- Make sure the food items are packed before putting in the freezer. Use freezer holders, tinfoil and damp-proof paper, plastic bag or similar packaging materials instead of traditional packaging paper.
- Mark each food pack by writing the date on the package before freezing. This will allow you to determine the freshness of each pack every time the freezer is opened. Keep the earlier food items in the front to ensure they are used first.
- Frozen food items must be used immediately after defrosting and must not be frozen again.
- Do not freeze large quantities of food all at once.

### Recommendations for storing frozen foods

The compartment must be set to at least -18°C.

1. Place the food items in the freezer as quickly as possible to avoid defrosting.

2. Before freezing, check the “Expiry Date” on the package to make sure it has not expired.
3. Make sure the food’s packaging is not damaged.

### Deep freezer details

As per the IEC 62552 standards, the freezer must have the capacity to freeze 4,5 kg of food items at -18°C or lower temperatures in 24 hours for each 100 litres of freezer compartment volume. Food items can only be preserved for extended periods at or below temperatures of -18°C . You can keep the foods fresh for months (in deep freezer at or below temperatures of 18°C ).

Food items to be frozen must not come into contact with the already frozen food inside the freezer to avoid partial defrosting of the already frozen food.

Boil the vegetables and filter the water to extend the frozen storage time. Place the food in air tight packages after filtering and place in the freezer. Bananas, tomatoes, lettuce, celery, boiled eggs, potatoes and similar food items should not be frozen. Freezing these food items will simply reduce the nutritional value and food quality, as well as possible spoiling which is harmful to health.

Freezer Compartment Setting	Cooler Compartment Setting	Descriptions
-18°C	4°C	This is the default, recommended setting.
-20,-22 or -24°C	4°C	Recommended for ambient temperatures exceeding 30°C.
Rapid Freeze	4°C	Use this to freeze food items in a short time, the product will reset to previous settings when the process is completed.
-18°C or colder	2°C	Use these settings if you believe the cooler compartment is not cold enough due to ambient temperature or frequently opening the door.

## Using the product

### Placing food

Freezer compartment shelves	Various frozen goods including meat, fish, ice cream, vegetables etc.
Cooler compartment shelves	Food items inside pots, capped plate and capped cases, eggs (in capped case)
Cooler compartment door shelves	Small and packed food or beverages
Vegetable bin	Fruits and vegetables
Fresh food compartment	Delicatessen (breakfast food, meat products to be consumed at short notice)

### Door open alert (Optional)

An audible alert will be heard if the product's door remains open for 1 minute. The audible alert will stop when the door is closed or any button on the display (if available) is pressed.

### Interior light

Interior light uses a LED type lamp. Contact the nearest Defy call centre for any problems with this lamp.



**IMPORTANT:** Check the trouble shooting list on the following page before contacting a Defy service centre. Doing so will save you time and money. This list includes frequent complaints that are not related to faulty workmanship or materials. Certain features mentioned herein may not apply to your product.

## 6 Maintenance and Cleaning

**Cleaning the product regularly will prolong its service life.**



**WARNING:** Disconnect the power before cleaning the refrigerator.

- Do not use sharp and abrasive tools, soap, house cleaning materials, detergents, gas, gasoline, varnish and similar substances for cleaning.
- Melt a teaspoonful of carbonate in the water. Moisten a piece of cloth in the water and wring out. Wipe the device with this cloth and dry off thoroughly.
- Take care to keep water away from the lamp's cover and other electrical parts.
- Clean the door using a wet cloth. Remove all items inside before detaching the door and chassis shelves. Lift the door shelves up to detach. Clean and dry the shelves, then attach back in place by sliding in from above.
- Do not use chloric water or cleaning products on the exterior surface and chrome-coated parts of the product. Chlorine will cause rust on such metallic surfaces.

### Preventing malodour

The product is manufactured free of any odorous materials. However, keeping the food in inappropriate sections and improper cleaning of internal surfaces may lead to malodour.

To avoid this, clean the inside with carbonated water every 15 days.

- Keep the foods in sealed holders. Microorganisms may spread out of unsealed food items and cause malodour.
- Do not keep expired and spoilt foods in the refrigerator.

### Protecting plastic surfaces

Oil spilled on plastic surfaces may damage the surface and must be cleaned immediately with warm water.

## 7 Troubleshooting

### **The refrigerator is not working.**

- The power plug is not fully settled. >>> *Plug it in to settle completely into the socket.*
- The fuse connected to the socket powering the product or the main fuse is blown. >>> *Check the fuses.*

### **Condensation on the side wall of the cooler compartment (MULTI ZONE, COOL, CONTROL and FLEXI ZONE).**

- The environment is too cold. >>> *Do not install the product in environments with temperatures below -5°C.*
- The door is opened too frequently >>> *Take care not to open the product's door too frequently.*
- The environment is too humid. >>> *Do not install the product in humid environments.*
- Foods containing liquids are kept in unsealed holders. >>> *Keep the foods containing liquids in sealed holders.*
- The product's door is left open. >>> *Do not keep the product's door open for long periods.*
- The thermostat is set to too low a temperature. >>> *Set the thermostat to an appropriate temperature.*

### **Compressor is not working**

- In case of sudden power failure or pulling the power plug off and putting back on, the gas pressure in the product's cooling system is not balanced, which triggers the compressor thermic safeguard. The product will restart after approximately 6 minutes. If the product does not restart after this period, contact service.
- Defrosting is active. >>> *This is normal for a fully automatic defrosting product. The defrosting is carried out periodically.*
- The product is not plugged in. >>> *Make sure the power cord is plugged in.*
- The temperature setting is incorrect. >>> *Select the appropriate temperature setting.*
- There is a power outage. >>> *The product will continue to operate normally once the power is restored.*

### **The refrigerator's operating noise is increasing while in use.**

- The product's operating performance may vary depending on the ambient temperature variations. This is normal and not a malfunction.

### **The refrigerator runs too often or for too long.**

- The new product may be larger than the previous one. Larger products will run for longer periods.
- The room temperature may be high. >>> *The product will normally run for long periods in a higher room temperature.*
- The product may have been recently plugged in or a new food item is placed inside. >>> *The product will take longer to reach the set temperature when recently plugged in or a new food item is placed inside. This is normal.*
- Large quantities of hot food may have been recently placed into the product. >>> *Do not place hot food into the product.*
- The doors were opened frequently or kept open for long periods. >>> *The warm air moving inside will cause the product to run longer. Do not open the doors too frequently.*
- The freezer or cooler door may be ajar. >>> *Check that the doors are fully closed.*
- The product may be set to too low a temperature. >>> *Set the temperature to a higher degree and wait for the product to reach the adjusted temperature.*
- The cooler or freezer door gasket may be dirty, worn out, broken or not properly settled. >>> *Clean or replace the gasket. A damaged / torn door gasket will cause the product to run for longer periods in order to maintain the current temperature.*

## Troubleshooting

---

### **The freezer temperature is very low, but the cooler temperature is adequate.**

- The freezer compartment temperature is set to a very low degree. >>> *Set the freezer compartment temperature to a higher degree and check again.*

### **The cooler temperature is very low, but the freezer temperature is adequate.**

- The cooler compartment temperature is set to a very low degree. >>> *Set the cooler compartment temperature to a higher degree and check again.*

### **The food items kept in cooler compartment drawers are frozen.**

- The cooler compartment temperature is set to a very low degree. >>> *Set the freezer compartment temperature to a higher degree and check again.*

### **The temperature in the cooler or the freezer is too high.**

- The cooler compartment temperature is set to a very high degree. >>> *The cooler compartment temperature setting influences the freezer compartment temperature. Change the cooler or freezer compartment's temperature and wait until the relevant compartments reach the adjusted temperature level.*
- The doors were opened frequently or kept open for long periods. >>> *Do not open the doors too frequently.*
- The door may be ajar. >>> *Fully close the door.*
- The product may have been recently plugged in or a new food item is placed inside. >>> *This is normal. The product will take longer to reach the set temperature when recently plugged in or a new food item is placed inside.*
- Large quantities of hot food may have been recently placed into the product. >>> *Do not place hot foods into the product.*

### **Shaking or noise.**

- The ground is not level or durable. >>> *If the product is shaking when moved slowly, adjust the feet to balance the product. Also make sure the ground is sufficiently durable to bear the product.*
- Any items placed on the product may cause noise. >>> *Remove any items placed on the product.*

### **The product is making noise of liquid flowing, spraying etc.**

- The product's operating principles involve liquid and gas flow. >>> *This is normal and not a malfunction.*

### **There is sound of wind blowing coming from the product.**

- The product uses a fan for the cooling process. This is normal and not a malfunction.

### **There is condensation on the product's internal walls.**

- Hot or humid weather will increase icing and condensation. This is normal and not a malfunction.
- The doors were opened frequently or kept open for long periods. >>> *Do not open the doors too frequently; if open, close the door.*
- The door may be ajar. >>> *Fully close the door.*

### **There is condensation on the product's exterior or between the doors.**

- The ambient weather may be humid, this is quite normal in humid weather. >>> *The condensation will dissipate when the humidity is reduced.*

## Troubleshooting

### The interior smells bad.

- The product is not cleaned regularly. >>> *Clean the interior regularly using a sponge, warm water and carbonated water.*
- Certain holders and packaging materials may cause odour. >>> *Use holders and packaging materials free of odour.*
- Foods were placed in unsealed holders. >>> *Keep food in sealed holders. Microorganisms may spread out of unsealed food items and cause malodour.*
- Remove any expired or spoilt foods from the product.

### The door is not closing.

- Food packages may be blocking the door. >>> *Relocate any items blocking the doors.*
- The product is not standing in the full upright position on the ground. >>> *Adjust the feet to balance the product.*
- The ground is not level or durable. >>> *Make sure the ground is level and sufficiently durable to bear the product.*

### The vegetable bin is jammed.

- Food items may be in contact with the upper section of the drawer. >>> *Reorganize the food items in the drawer.*



**Warning:** If you cannot eliminate the problem although you follow the instructions in this section, contact the nearest Defy service centre. Never try to repair a non-functional refrigerator yourself.



**Warning: Never dispose of the Refrigerator in a fire.**



Do not dispose of your Refrigerator along with regular household waste.

**Contact your local authority for disposal information and facilities available.**

Please register your product at  
**www.defy.co.za**  
DEFY APPLIANCES (PTY) LTD  
P.O.BOX 12004  
JACOBS  
DURBAN  
4026  
SOUTH AFRICA

Record in the space below the listed information for future reference.

SERIAL NUMBER.....

DATE OF PURCHASE.....

PURCHASED FROM.....

.....



## 8 Branches

If you have followed the instructions and still have a problem, contact the customer care line on 086 100 3339. They will be able to advise you on any aspect of the product or send a qualified technician to repair it.

---

### South African Branches:

#### **BLOEMFONTEIN**

Unit Number 5  
Monument Business Park  
50 Monument Road  
Oranjesig, Bloemfontein  
[Bloemfontein.Service@defy.co.za](mailto:Bloemfontein.Service@defy.co.za)

#### **CAPE TOWN**

5A Marconi Rd. Montague Gardens, 7441  
[CapeTown.Service@defy.co.za](mailto:CapeTown.Service@defy.co.za)

#### **DURBAN**

135 Teakwood Road, Jacobs,  
Durban, 4052  
[Durban.Service@defy.co.za](mailto:Durban.Service@defy.co.za)

#### **EAST LONDON**

Robbie de Lange Road, Wilsonia,  
East London, 5201  
[EastLondon.Service@defy.co.za](mailto:EastLondon.Service@defy.co.za)

#### **GAUTENG, MIDRAND**

127 15th Road, Cnr Pharmaceutical & 15th Rd,  
Midrand, Gauteng  
[Gauteng.Service@defy.co.za](mailto:Gauteng.Service@defy.co.za)

#### **POLOKWANE**

87 Nelson Mandela Drive, Superbia 0699  
[Polokwane.Service@defy.co.za](mailto:Polokwane.Service@defy.co.za)

#### **PORT ELIZABETH**

112 Patterson Road, North End, Port Elizabeth  
6001  
[PortElizabeth.Service@defy.co.za](mailto:PortElizabeth.Service@defy.co.za)

### Sub-Saharan Africa Branches:

#### **ZAMBIA: SOUTHGATE INVESTMENTS LTD**

Plot 1606, Sheki Sheki Road  
P.O. Box 33681  
Lusaka, 10101, Zambia  
Tel: +260 0211 242332/3  
Fax: +260 0211 242933  
[sgiservicecentre@microlink.zm](mailto:sgiservicecentre@microlink.zm)

#### **NAMIBIA: ATLANTIC DISTRIBUTORS (PTY) LTD**

10 Tienie Louw Street, Northern Industrial Area  
P.O. Box 21158, Windhoek, Namibia  
Tel: (061) 216162  
Fax: (061) 216134  
[atlantic@mweb.com.na](mailto:atlantic@mweb.com.na)

#### **ZIMBABWE: TRADECOMAFRICA**

Trade Com Africa, 183 Loreley Crescent  
Msasa, Harare, Zimbabwe  
Tel: +263 4 486165/6  
Cell: +263 772 469010  
Cell: +263 772 469011

#### **BOTSWANA: RAY MORGAN AGENCIES**

RMA Service Centre, Plot 48, East Gate  
Gaborone International Commerce Park  
Kgale View, Gaborone  
Botswana  
Tel: +267 390 3996 / 390 3912  
Fax: +267 318 7376  
Cell: +267 7134 6539  
[service@rma.co.bw](mailto:service@rma.co.bw); [raja@rma.co.bw](mailto:raja@rma.co.bw)

#### **SWAZILAND: LYNDS DISTRIBUTORS**

P.O Box 716, Mbabane, Swaziland, H100  
Tel: (00268) 2515 4310/8  
Fax: (00268) 2518 4318

#### **MOZAMBIQUE: COOL WORLD. LDA**

Rua da Resistencia No. 97B R/C  
Cell: +258 84 44 61 234  
[coolworldlda@hotmail.com](mailto:coolworldlda@hotmail.com)  
Nosso Show Room  
Av: da Industrias, Parcela No.735 \* 735A  
Machava, Maputo

---

## 9 Warranty

---

This certificate is issued by DEFY APPLIANCES (PTY) LIMITED manufacturers of Defy and Ocean products, hereinafter the Company, to the original purchaser only, of the appliance described on the certificate and shall constitute the only warranty given in respect of this appliance.

The Company warrants to the original purchaser that for a period of \*THREE YEARS from date of purchase, plus an additional \*TWO years on registration, the appliance is free from defect under normal domestic use, both in workmanship and material, subject to the following conditions.

1. Repair or replacement of any part of this appliance, found by the Company to be defective, shall be at the election of the Company. The Company reserves the right to effect such service through any of its Service Divisions or Authorised Service Dealers. The cost of such service shall be borne by the Company in full, provided that the appliance is located no further than 50km from a Company Service Centre or an Authorised Service Dealer. Where the appliance is located beyond the 50km radius, the purchaser shall be liable for the standard travelling charges, as determined by the Company.
2. Vitreous enamelware, fuses and lamps are specifically excluded from these warranties. It is an express condition of these warranties that the purchaser takes due care and attention in the use and maintenance of the appliance. Abuse, misuse in conflict with operating instructions, connection to incorrect voltages and subjection to commercial use shall release the Company from its obligations.
3. This warranty shall become void and cease to operate if the appliance is dismantled by, or any repairs to the appliance are effected by any persons not duly authorised by the Company, or if substitute parts not approved by the Company are used in the appliance, or if the serial number of the appliance is removed.
4. The Company shall not be responsible for damages resulting from fire, flood, civil disturbances or any Act of God. The Company shall not, in terms of these warranties be responsible nor held liable for any consequential loss or damage of any kind caused by or due to the failure or malfunction of the appliance. The Company shall not be responsible for damages caused by insect and/or animal infestation.
5. The Company shall not be responsible for transportation or other costs other than those incurred within the provisions of Point 1 of this Certificate.
6. **For warranties in the Republic of South Africa and Sub-Saharan Africa, please contact the customer care line. Please refer to the previous page for respective South African branches and Sub-Saharan Africa branches.**
7. Where service is requested under warranty and no fault or defect can be found by the Company, all costs incurred will be for the purchaser's account.
8. This Certificate as well as your invoice will serve as proof of purchase. For the purpose of warranty, it will be essential to produce this Certificate and invoice. Failure to do so, will render the purchaser liable for service costs.

### **KEEP THIS CERTIFICATE AND SALES INVOICE AS PROOF OF PURCHASE FOR WARRANTY PURPOSES.**

\*THREE YEARS full coverage, additional \*TWO YEARS (with registration) will cover only parts, labour cost to be charged accordingly. Please register your product at [www.defy.co.za](http://www.defy.co.za) in order to activate the additional two year warranty.