

C366-C367-C368-C385-C386-C387
60 CM REFRIGERATORS

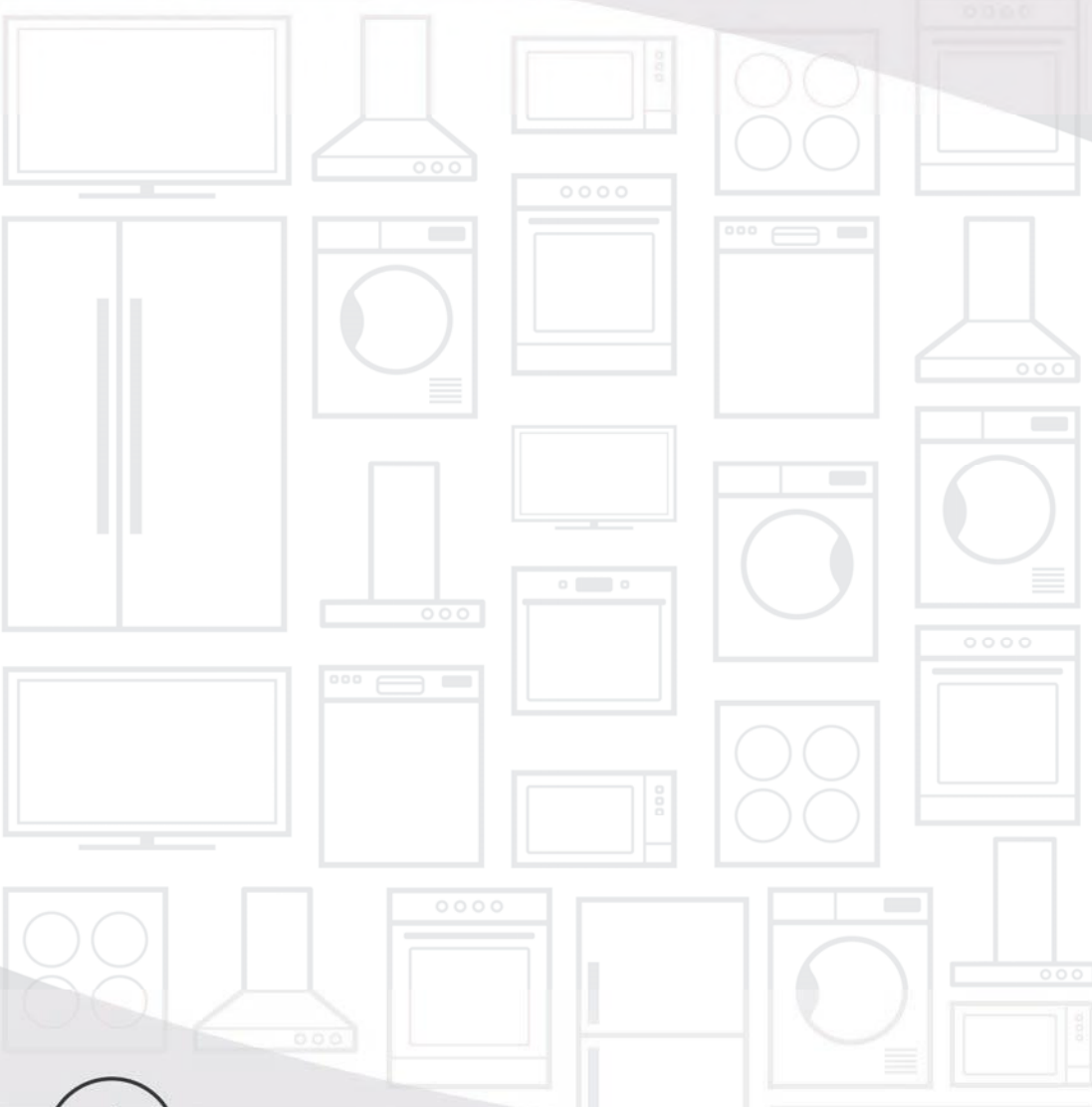

Believe in better



Customer Care Line
(after sales service)

086 100 3339

Part number: 3816570100 AG



Refrigeration
Instruction manual

Read this manual before initial installation and operation of the product!

Dear Customer,

Your new Defy refrigerator was manufactured in a state of the art facility and has passed the strictest quality control procedures. Please read this manual carefully before using your product for the first time and then store it within easy reach for future reference. We trust you will enjoy years of trouble free use.

The user manual:

- This manual will provide you with information on how to safely operate and care for your product in order that you gain the maximum benefit from it.
- Pay particular attention to any safety instructions.
- Please read all additional documents supplied with your product.
- Please note that this manual may be used for several similar but different models. Please check for relevance regarding your particular model.

Explanation of symbols used in this manual

 Important safety information. Warning for hazardous situations with regard to life and property.

 Caution; Warning for supply voltage.

 Caution; Warning for fire hazard.

 Caution; Warning for hot surfaces.

 Useful information. Important information or useful hints about usage.



Unpacking

Remove all packaging.



Ensure that packing material is disposed of in a responsible manner and that any plastic bags are cut up to prevent children playing with them and accidentally suffocating.

If the refrigerator is damaged in any way do not use it. Report the damage to your dealer who will take the necessary corrective action.

	This refrigerator is not intended for use by persons (including children) with reduced physical, sensory or mental capabilities or lack of experience and knowledge, unless they have been given supervision or instruction concerning the use of the refrigerator by a person responsible for their safety.
	Children should be supervised to ensure that they do not play with the refrigerator.

Contents

<u>1. Your Refrigerator</u>	4	<u>4. Using your refrigerator</u>	14
		Models C368 & C387	14
<u>2. Important Safety Information</u>	7	Models C386	16
Warnings	7	Models C366, C367 & C385	17
Child safety	9	<u>5. The freezer compartment</u>	19
HCA Warning	9	Deep Freeze packaging information	19
Energy saving tips	10	Freezer compartment settings	20
Recommendations for fresh food compartment	10	Placing the food	20
Anti bacterial strip	10	<u>6. Water Dispenser</u>	21
		Cleaning the water tank	21
		Icematic and ice storage container	22
		<u>7. Maintenance and cleaning</u>	23
<u>3. Placing and Installation</u>	11	<u>8. Trouble Shooting</u>	24
Transportation instructions	11	<u>9. Refrigerator specifications</u>	26
Before using the refrigerator	11	<u>10. Branches</u>	27
Electrical connection	11	<u>11. Warranty</u>	28
Adjusting the feet	12		
Reversing the doors	12		

	Warning: Do not place any copper pots or dishes inside the cabinet.
	Figures in this manual are schematic and may not match your refrigerator exactly.
	Values stated on the machine labels or in the documentation accompanying it are obtained in laboratory conditions in accordance with the relevant standards. Depending on operational and environmental conditions of the machine, these values may vary.
	Please note that this manual may be used for several similar but different models. Please check for relevance regarding your particular model.

1 Your Refrigerator

Full No Frost Refrigerators

Models:

C368

C387



7(b)

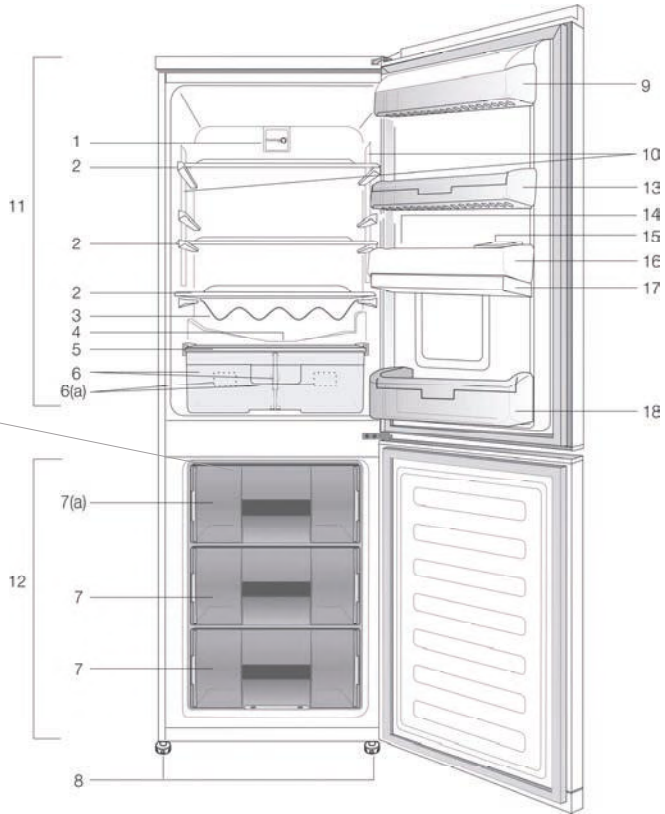

- | | |
|--|---|
| 1. Fan | 9. Dairy shelf |
| 2. Adjustable shelves | 10. Side illumination* |
| 3. Bottle rack | 11. Fridge compartment |
| 4. Defrost water collection channel - Drain tube | 12. Freezer compartment |
| 5. Crisper cover | 13. Door shelf |
| 6. Salad crisper with separator | 14. Egg tray |
| 6(a). Blue light* | 15. Water dispenser filling container * |
| 7(a). Freezer drawer with ice tray * | 16. Water dispenser upper shelf * |
| 7(b). Freezer drawer with Icematic and ice storage container * | 17. Water dispenser tank * |
| 7. Freezer drawer | 18. Bottle shelf |
| 8. Adjustable front feet | * (Depends on Model). |



The manufacturer strives for continuous improvement. For this reason, technical specifications, text and illustrations in this manual are subject to change without notice.

Figures represented in this instruction manual are schematic and may not correspond exactly with your refrigerator. If the parts are not included in the refrigerator you have purchased, they may be model specific and therefore only valid for some models.

Semi No Frost Refrigerators

Models:
C386

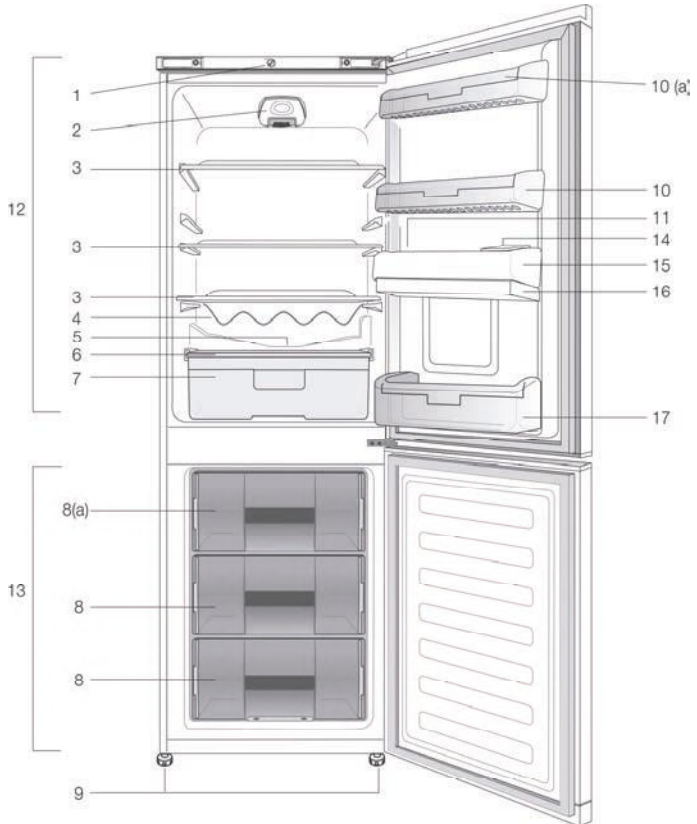

- | | | | |
|-------|--|--------|---------------------------------------|
| 1. | Thermostat knob | 9. | Adjustable front feet |
| 2. | Interior light | 10(a). | Dairy shelf * |
| 3. | Adjustable shelves | 10. | Door shelf |
| 4. | Bottle rack * | 11. | Egg tray |
| 5. | Defrost water collection channel
- Drain tube | 12. | Fridge compartment |
| 6. | Crisper cover | 13. | Freezer compartment |
| 7. | Salad crisper
* (Depends on Model). | 14. | Water dispenser filling container * |
| 8(a). | Freezer drawer with ice tray | 15. | Water dispenser upper shelf * |
| 8. | Freezer drawer | 16. | Water dispenser tank * |
| | | 17. | Bottle shelf
* (Depends on Model). |

Auto Defrost Refrigerators

Models:

C366

C367

C385

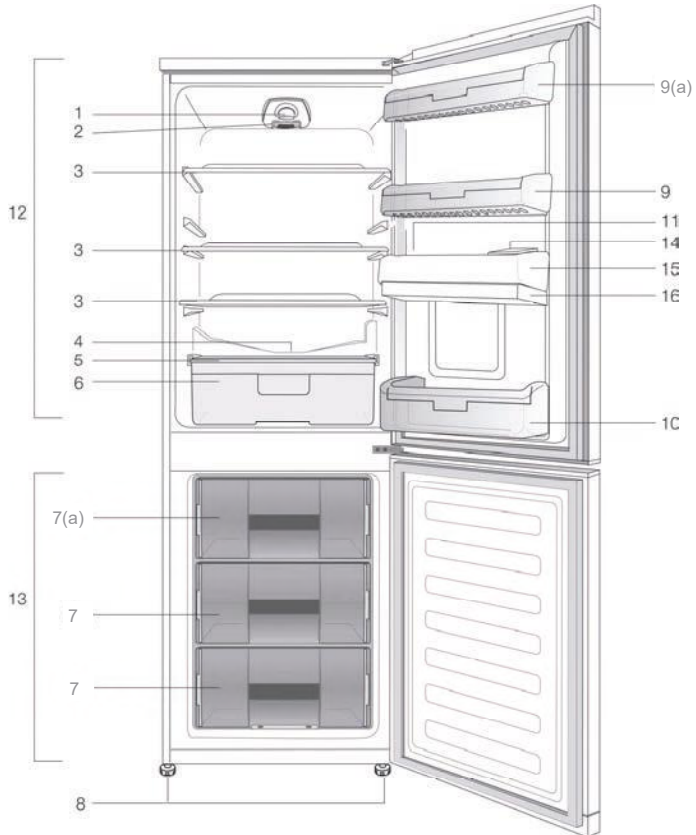

- | | | | |
|-------|--|-------|---|
| 1. | Thermostat knob | 8. | Adjustable front feet |
| 2. | Interior light | 9(a). | Dairy shelf |
| 3. | Adjustable shelves | 9. | Door shelf |
| 4. | Defrost water collection channel
- Drain tube | 10. | Bottle shelf |
| 5. | Crisper cover * | 11. | Egg Tray |
| 6. | Salad crisper
* (Depends on Model). | 12. | Fridge compartment |
| 7(a). | Freezer drawer with ice tray | 13. | Freezer compartment |
| 7. | Freezer drawer | 14. | Water dispenser filling container * |
| | | 15. | Water dispenser upper shelf * |
| | | 16. | Water dispenser tank *
* (Depends on Model). |

2 Important safety information

Please review and observe the following information. Failure to do so may result in injuries or material damage and will render any warranty and reliability commitments void. Spare parts for the refrigerator will be stocked for 10 years to meet any maintenance or service requirements.

Warnings

- Hand this owners manual over to the new owner should ownership change.
- The refrigerator must only be used for its intended purpose, i.e. the storing of edible foodstuff.
- The refrigerator is intended to be used in household and similar applications such as staff kitchen areas in shops, offices and other working environments; farm houses and by clients in hotels, motels and other residential type environments; bed and breakfast type environments; catering and similar non-retail applications.
- Consult with your authorised DEFY service centre for all questions and problems relating to the refrigerator. Only authorised agents are to carry out repairs.
- Vapour and vaporized cleaning materials must never be used in the cleaning and defrosting the refrigerator. The vapour may come into contact with the electrical parts and cause a short circuit or electric shock.
- Do not allow children to hang on the refrigerator door as the unit could topple forward risking personal injury. Never use the parts on your refrigerator, such as the door, as a means of support or step.
- Do not use electrical appliances inside the refrigerator or freezer.
- Keep ventilation openings, in the refrigerator or in the built-in structure, clear of obstructions.
- Unplug the refrigerator when cleaning, during routine maintenance or if it will not be used for an extended period.
- To unplug the refrigerator, remove the plug by pulling on the plug and not the cable!
- Exposing the refrigerator to rain, snow, sun and wind is an electrical safety risk.
- Should the mains lead of the refrigerator become damaged or should it need replacing at any time, it must be replaced by a special purpose made mains lead which can only be obtained from a DEFY Authorised Service Agent.
- Never connect your refrigerator to electricity saving systems as they may damage the refrigerator.
- Do not store medicine or academic research samples which require strict temperature control in the refrigerator.
- Do not store or use flammable gas, benzene, petrol or volatile substances in or near the refrigerator.
- Do not store explosive substances such as aerosol cans with a flammable propellant in the refrigerator.
- In the event of a malfunction, disconnect the refrigerator from the power supply.
- If there is a blue light fitted on the refrigerator, do not look at the blue light through optics.
- Ensure the fridge contents do not touch the back wall of the refrigerator to prevent them from freezing.

- Do not overload your refrigerator with excessive amounts of food. If overloaded, the food items may fall down and injure you and damage the refrigerator when you open the door. Never place objects on top of the refrigerator, they may fall down and injure you when you open or close the refrigerator door.
- The refrigerator may move if the adjustable legs are not properly levelled on the floor. Levelling the adjustable legs on the floor helps prevent the refrigerator from moving.
- When carrying the refrigerator, do not hold on the door handle as this may cause the handle to break.
- When placing your refrigerator next to another refrigerator or freezer, the distance between the devices should be at least 80 mm. Failure to do so may cause adjacent walls to humidify.
- For refrigerators with a freezer compartment; Do not put bottled and canned liquid beverages in the freezer compartment as they may burst.
- Do not touch frozen food with your hands; they may stick to your hand.
- Never pour or spray water into or on the refrigerator and do not store liquids, pot plants or open containers on top of the refrigerator as these might spill causing electrical shorting.
- For manually controlled refrigerators, wait at least 5 minutes before starting the refrigerator after a power failure.
- Avoid any damage to the power cable when transporting the refrigerator.



- Bending the cable may cause a fire.
- Never place heavy objects on the power cable.
- Do not touch the plug with wet hands.
- Do not plug in the refrigerator if the wall socket is loose.
- On delivery, check to make sure that the refrigerator is not damaged and that all the parts and accessories are in perfect condition.
- Ensure that the plug remains readily accessible. Do not use multiple adapter plugs or an extension cable.
- Ensure that there is sufficient spacing between the refrigerator and surrounding walls.
- Unplug the refrigerator from the mains when you clean the refrigerator.

	<p>The electrical safety of the refrigerator is only guaranteed if the earth system of your home is compliant to national standards.</p>
	<p>Never plug the refrigerator into the wall socket during installation. Death or serious injury may result.</p>

Child safety



- If the door has a lock, the key should be kept out of reach from children.
- If you are discarding an old refrigerator with a lock or latch fitted to the door, disable the lock/latch, and ensure that the refrigerator is left in a safe condition to prevent children from being trapped inside and suffocating.
- Children must be supervised to prevent them from tampering with the refrigerator.

HCA Warning Refrigerator cooling systems containing R600a:

At DEFY, the care and protection of our environment is an on going commitment. This DEFY refrigerator is particularly environmentally friendly and contains non CFC / HFC natural substances in the cooling system (Called R600a) and in the insulation (Called cyclopentane). These are potentially flammable if exposed to fire. Take care not to damage, the cooling circuit / pipes of the refrigerator in transportation and in use.

In case of damage do not expose the refrigerator to fire or potential ignition sources and immediately ventilate the room where the refrigerator is situated.

Ignore this warning if your refrigerators cooling system contains R134a.

	Do not drill, cut or modify the refrigerator. Injuries may result if the refrigerant circuit is damaged. See HCA warning. Do not damage the refrigerant circuit.
	Do not operate a damaged refrigerator. Consult with your nearest DEFY service centre should you have any concerns
	Repairs must be carried out by authorised persons only. Repairs carried out by incompetent persons create a user risk.
	Contact your local authority for disposal information and facilities available.
	Do not dispose of your Refrigerator along with regular household waste.
	Warning: Never dispose of the Refrigerator in a fire.

Energy saving tips

- Ensure your refrigerator is installed in a well ventilated area. If the ambient temperature is low (but in no case lower than 5°C), then the energy saving will be more. Do not install your refrigerator under direct sunlight or near heat emitting appliances such as ovens, dishwashers or radiators.
- Ensure the time between buying chilled/frozen food and placing it in the refrigerator is kept at a minimum, particularly in summer. Use a cooler bag or a special carrier bag to carry frozen food. Do not put hot food or drinks in the refrigerator.
- Do not leave the door(s) of your refrigerator open for long periods of time and ensure they are closed properly after each opening.
- Defrost frozen food in the fridge compartment, so that frozen food acts as an ice pack to assist cooling in the fridge. This will provide energy saving and preserve the food quality.
- Do not put hot food or drinks in your refrigerator.
- Do not overload your refrigerator. This restricts effective air circulation in the refrigerator.
- Keep food in closed containers.

Recommendations for fresh food compartment

(Depends on model)

- Please do not let any foods come into contact with the temperature sensor in the fresh food compartment. In order to maintain the fresh food compartment at the ideal storage temperature, the sensor must not be interfered with by any foods.
- Do not place hot foods in your refrigerator.

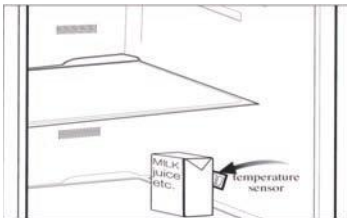
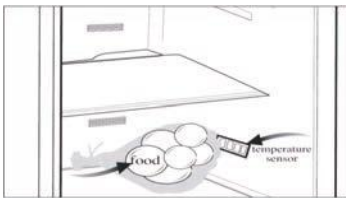

Anti bacterial strip (Carbon strip) (Depends on model)

The anti bacterial strip prevents unpleasant odour build-up in the refrigerator. To clean the strip, open the strip cover with a thin screwdriver and then pull the cover downwards and remove the cover. Remove the strip as per the diagram. To clean the strip, leave it in the sun for one day. Refit the strip. Clean the strip once a year.

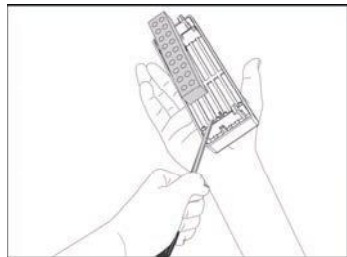
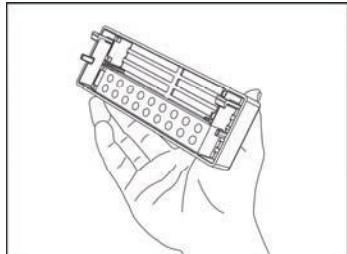
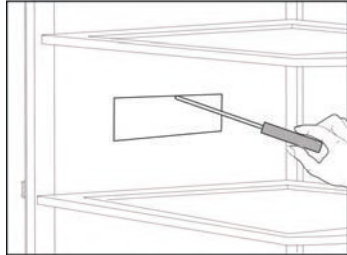

3 Placing and Installation

Transportation instructions

1. The refrigerator must be transported only in an upright position. The packing must be intact during transportation.
2. When positioning your refrigerator, take care not to damage flooring, pipes, wall coverings etc. Do not move the refrigerator by pulling the door or handle.

When re-transporting your refrigerator

- Your refrigerator must be emptied and cleaned prior to any transportation.
- The shelves, accessories, crisper etc. In your refrigerator must be fastened securely with adhesive tape to protect against any jolts.
- Packaging must be tied with thick tape and strong rope and the transportation guidelines printed on the package must be followed.

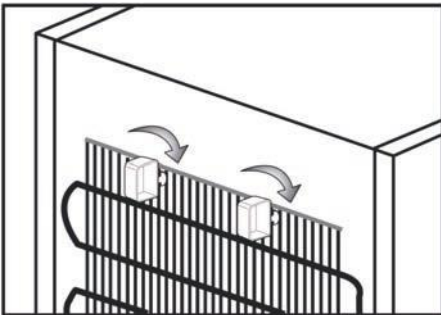

1. Install your refrigerator in a place that allows for ease of use.
2. Keep your refrigerator away from heat sources such as stoves, geysers humid places and direct sunlight.
3. There must be appropriate air ventilation around your refrigerator in order to achieve efficient operation. The refrigerator is to have at least a 50 mm space from the ceiling and at least a 50 mm space from the wall. Fit the Two plastic wall spacers supplied with the appliance rotating 1/4 turn to the condenser at the back of the appliance (See Diagram).



If the floor is covered with a carpet, your refrigerator must be elevated 25 mm from the floor.

4. Place your refrigerator on an even floor surface to prevent jolts.
5. Do not keep your refrigerator in ambient temperatures under 10°C.

Please make sure that the interior of your refrigerator is cleaned thoroughly.

	Your refrigerator should be installed at least 30 cm away from heat sources such as hobs, ovens, central heaters and stoves and at least 5 cm away from electrical ovens and should not be located under direct sunlight.
	
	If two refrigerators are to be installed side by side, there should be at least 8 cm distance between them.

Before using the refrigerator

1. The feet have been adjusted for perfect levelling.
2. The interior of the refrigerator is clean and dry.
3. Check the required distance between your refrigerator and the wall in order to allow for free air circulation.
4. The plug has been inserted into the wall socket and the electricity is switched on. When the door is open the interior light will come on.
5. You may hear a noise as the compressor starts up. The liquid and gases sealed within the refrigeration system may also give rise to noise, even if the compressor is not running, this is quite normal.
6. Do not load the refrigerator immediately after it is switched on. Wait until the correct storage temperature has been reached.

Electrical connection

Connect your refrigerator to a grounded socket which is protected by a fuse with the appropriate capacity.

Important

The connection must be in compliance with national regulations. The power cable plug must be easily accessible after installation. The specified voltage must be equal to your mains voltage.

When operating your refrigerator for the first time, please observe the following instructions during the initial six hours:

- The door should not be opened frequently.
- The refrigerator must be operated empty without any food in it.
- Do not unplug your refrigerator.
- Original packaging and foam materials should be kept for any future transportation or moving.

The manufacturer shall not be held liable if the information given in the instruction manual is not followed.

	The front edges of the refrigerator may feel warm. This is normal. These areas are designed to be warm in order to avoid condensation.
	A damaged power cable must be replaced by a qualified electrician.
	Extension cables and multiway plugs must not be used for connection.
	A damaged refrigerator must not be operated before it is repaired! There is danger of an electric shock!
	Important! Care must be taken while cleaning/ carrying the refrigerator not to touch the bottom of the condenser metal wires at the back of the refrigerator, as this could cause injury.
	DEFY declines to accept any liability should the instructions not be followed.

Adjusting the feet

The refrigerator may move if the adjustable legs are not properly levelled on the floor.

Levelling the adjustable legs on the floor:

Level your refrigerator by turning the front legs as shown in the illustration below.

The corner where the legs are is lowered when the leg is turned in the direction of the black arrow and raised when turned in the opposite direction. Having someone to carefully assist in tilting the refrigerator slightly will help facilitate this process.

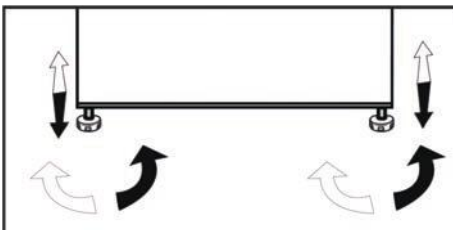

Reversing The Doors (Depends on model)

We recommend that you reverse doors (if required) before switching on for the first time.

Tools required:

Small and medium size screwdrivers and a pair of pliers.

Spare Parts:

The following parts, which are exclusively for left hand side fitted hinge operation are available for purchase from Defy spares:

- Upper door top trim hinge covers – there are 2 different parts, one for each side of the top trim.
- Upper door middle hinge bushing / door stopper assembly.

Keep all the parts supplied in the plastic bag (and parts which have been removed when reversing doors) in a safe place for possible future re-use.

	Important: Have somebody to assist you when moving the refrigerator and to hold the doors when removing / re-fitting hinges and doors to avoid injury and damage to the product
--	--

Please refer to diagrams supplied.

	Using the screws and plastic plugs supplied in the installation kit purchased from Defy spares, fit handles to the desired side (see diagram for locations) NOTE: Depends on model. Some models have integrated handles that are universal to left and right hand sides and do not need to be swapped.
--	--

	Figures represented in this instruction manual are schematic and may not correspond exactly with your refrigerator. If the parts are not included in the refrigerator you have purchased, they may be model specific and therefore only valid for some models.
--	--

Reversing the doors

Proceed in numerical order

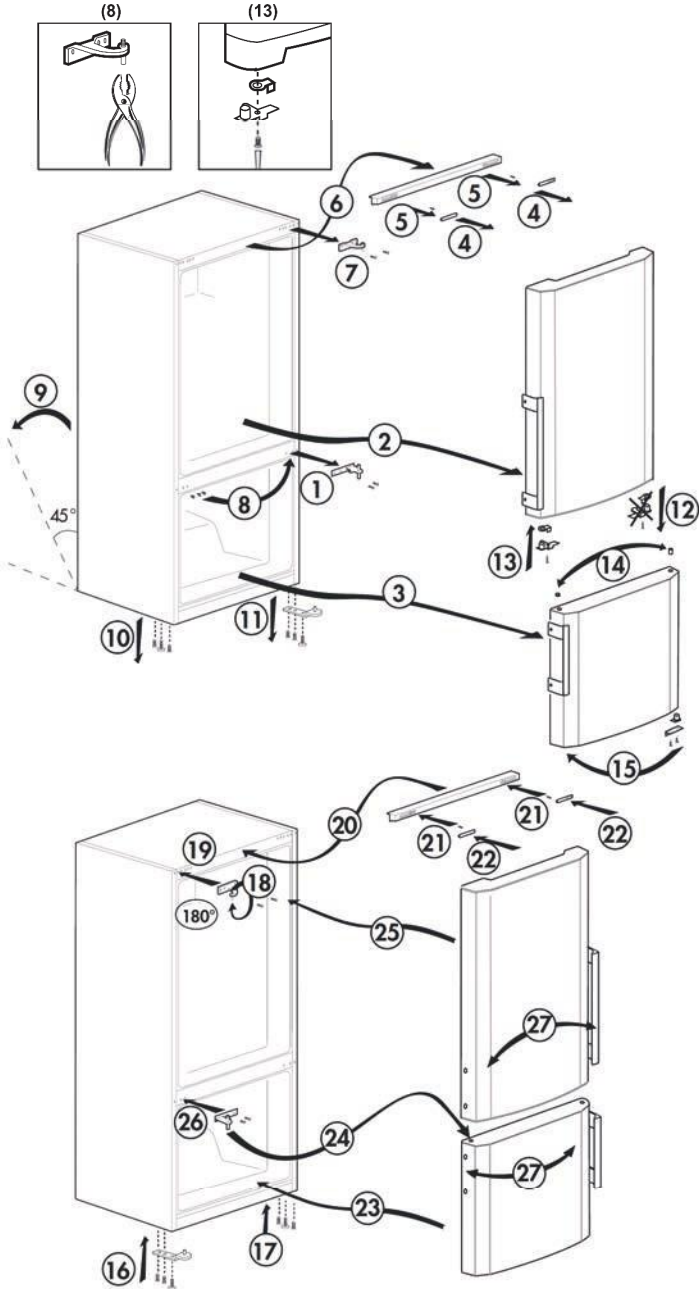

4 Using your refrigerator

Models:

C368

C387

Indicator Panel

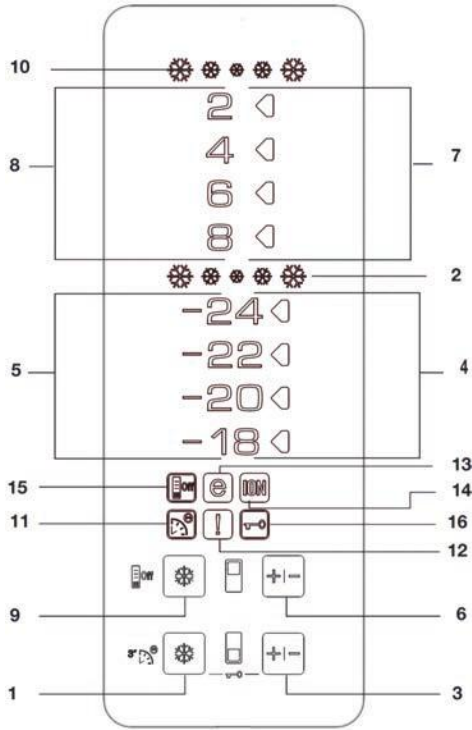

Indicators & button functions

1. Fast Freeze Function

The Fast Freeze indicator turns on when the Quick Freeze function is on.

To cancel this function press the Fast Freeze button again. The Fast Freeze indicator will turn off and return to its normal settings.

If you do not cancel the Fast Freeze function it will automatically cancel itself after 4 hours or when the freezer compartment reaches the required temperature.

If you require large amounts of fresh food to be frozen, press the Fast Freeze button before placing the food into the freezer compartment.

If you press the Fast Freeze button repeatedly and at short intervals, the electronic circuit protection will be activated and the compressor will not start up immediately.

Please Note: This function is not recalled when power restores after a power failure.

2. Quick Freeze Indicator

This icon flashes in an animated style when the Quick Freeze function is active.

3. Freezer Set Function

This function allows you to set the freezer compartment temperature. Press this button to set the temperature of the freezer compartment to -18°C, -20°C, -22°C and -24°C respectively.

4. Freezer Compartment Temperature Setting Indicator

Indicates the temperature set for the Freezer Compartment.

5. Freezer Compartment Temperature Indicator

-24°C, -22°C, -20°C, -18°C indicators light up continuously.

6. Fridge Set Function

This function allows you to set the fridge compartment temperature.

Press this button to set the temperature of the fridge compartment to 8°C, 6°C, 4°C, 2°C respectively.

7. Fridge Compartment Temperature Setting Indicator

Indicates the temperature set for the Fridge Compartment.

8. Fridge Compartment Temperature Indicator

8°C, 6°C, 4°C and 2°C indicators light up continuously.

9. Quick Fridge Function

When the Quick Fridge button is pressed, the temperature of the compartment will become colder than the set values.

This function can be used to rapidly cool food placed in the fridge compartment. If you want to cool large amounts of fresh food, it is recommended that you activate this feature before placing the food into the fridge.

The Quick Fridge indicator will remain lit when the Quick Fridge function is enabled. To cancel this function press the Quick Fridge button again.

The Quick Fridge indicator will turn off and settings will return to normal.

If you do not cancel Quick Fridge then it will automatically cancel itself after 2 hours or when the fridge compartment reaches the required temperature.

Please Note: This function is not recalled when power restores after a power failure.

10. Quick Fridge Indicator

This icon flashes in an animated manner when the Quick Fridge function is active.

11. Eco-Fuzzy (Special Economic Usage) Function

Press the Quick Freeze button for 3 seconds to activate the Eco Fuzzy Function.

The Refrigerator will start operating in the most economic mode at least 6 hours later and the economic usage indicator will turn on when the function is active.

Press the Quick Freeze button for 3 seconds to deactivate the Eco Fuzzy Function.

12. High Temperature/ Error Warning Indicator

This light comes on during high temperature failures and error warnings.

13. Economic Usage Indicator

Indicates that the refrigerator is running in energy-efficient mode. This indicator will be active if the Freezer Compartment temperature is set to 18°C. The Economic Usage Indicator turns off when the Quick Fridge or Quick Freeze function is selected.

14. Ionizer Indicator Light (Depends on Model).

Indicator light lights up continuously. This light indicates that your refrigerator is protected against bacteria.

15. Energy Saving Function

When you press this button, the Energy saving icon will light up and the Energy Saving Function will be activated. If the Energy saving function is active, all icons on the display other than the Energy saving icon will turn off.

If any other button is pressed or the door is opened when the Energy Saving Function is active, the Energy Saving Function will be deactivated and the icons on the display will return to normal.

If you press this button again, the Energy Saving icon will turn off and the Energy Saving Function will no longer be active.

16. Key Lock Mode

Press the Quick Freeze and FRZ Set buttons concurrently for 3 seconds. The Key lock icon will light up and the key lock mode will be activated.

Buttons will not function if the Key Lock mode is active. Press Quick Freeze and FRZ Set buttons concurrently for 3 seconds again. The Key lock icon will turn off and the key lock mode will be deactivated.

Door Open Warning

An audio warning will be given when the fridge compartment door of your refrigerator is left open for a certain period of time. The audio warning signal will mute when pressing any button on the indicator or when the door is closed.

Dual cooling system

Your refrigerator is equipped with two separate cooling systems to cool the fresh food compartment and freezer compartment.

Thus, air in the fresh food compartment and freezer compartment do not get mixed. Thanks to these two separate cooling systems, cooling speed is much higher than other refrigerators.

Odour's in the compartments do not get mixed.

Additional power saving is also achieved since the defrosting is performed individually.

Egg tray

You can install the egg holder to the desired door or body shelf.

Never store the egg holder in the freezer compartment .

Ionizer

The Ionizer, which is in the air channel of the refrigerator, ionizes the air. This system ensures that airborne bacteria and bad smells that originate from the bacteria will be reduced.

Blue light (Depends on Model).

Food stored in the crispers that are illuminated with a blue light continue their photosynthesis by means of the wavelength effect of blue light and thus, preserve their freshness and increase their vitamin content.

Using your refrigerator

Models:
C386

Temperature control and adjustment

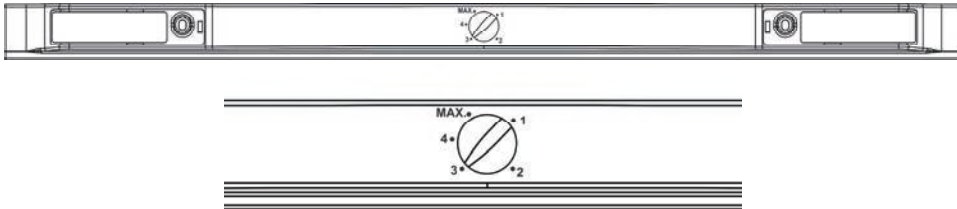

Operating temperatures are controlled by the thermostat knob (see diagram) located on the cabinet top trim, visible when the refrigerator door is open.

Settings may be made from 1 to Max, Max being the coldest position.

When the appliance is switched on for the first time, the thermostat should be adjusted so that after 24 hours, the average fridge temperature is no higher than +5°C.

Set the thermostat half way between the 1 and Max setting and monitor to obtain the desired temperature i. e. towards Max you will obtain a colder fridge temperature and vice versa.

Some sections of the fridge may be cooler or warmer. (such as the salad crisper and the top part of the cabinet). This is quite normal.

The normal storage temperature of the freezer should be -18°C.

Lower temperatures may be obtained by adjusting the thermostat knob towards the Max position.

Check the temperature with an accurate thermometer to ensure that the storage compartments are kept to the desired temperature.

Remember to take the reading very quickly since the thermometer temperature will rise very rapidly after it has been removed from the freezer.

Each time the door is opened cold air escapes and the internal temperature rises. Therefore never leave the door open and ensure it is closed immediately after food is added or removed.

In case of a temporary ice build up in the fridge compartment, reduce the thermostat setting to 1, monitoring at the same time that the fridge temperature is maximum +5°C.

Once the ice build up disappears and the refrigerator starts auto defrosting again as normal, then you may increase the thermostat setting, if required.



Figures represented in this instruction manual are schematic and may not correspond exactly with your refrigerator. If the parts are not included in the refrigerator you have purchased, they may be model specific and therefore only valid for some models.

Using your refrigerator

Models:

C366

C367

C385

Temperature control and adjustment

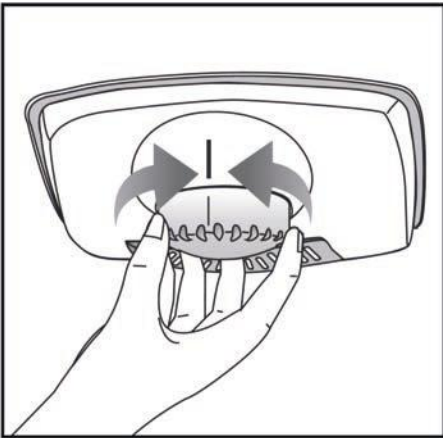

Operating temperatures are controlled by the thermostat knob (see diagram) located on the ceiling of the fridge compartment. Settings may be made from 1 to 5, 5 being the coldest position.

When the appliance is switched on for the first time, the thermostat should be adjusted so that after 24 hours, the average fridge temperature is no higher than +5°C.

Set the thermostat half way between the 1 and 5 setting and monitor to obtain the desired temperature i. e. towards 5 you will obtain a colder fridge temperature and vice versa. Some sections of the fridge may be cooler or warmer. (such as the salad crisper and the top part of the cabinet). This is quite normal.

The normal storage temperature of the freezer should be -18°C. Lower temperatures may be obtained by adjusting the thermostat knob towards position 5.

Check the temperature with an accurate thermometer to ensure that the storage compartments are kept to the desired temperature. Remember to take the reading very quickly since the thermometer temperature will rise very rapidly after it has been removed from the freezer.

Each time the door is opened cold air escapes and the internal temperature rises. Therefore never leave the door open and ensure it is closed immediately after food is added or removed.

In case of a temporary ice build up in the fridge compartment, reduce the thermostat setting to 1, monitoring at the same time that the fridge temperature is maximum +5°C. Once the ice build up disappears and the refrigerator starts auto defrosting again as normal, then you may increase the thermostat setting, if required.

Defrosting Fridge compartment

The fridge compartment defrosts automatically. The defrosting water runs to the drain tube via a collection container at the back of the appliance (1). (See diagram).

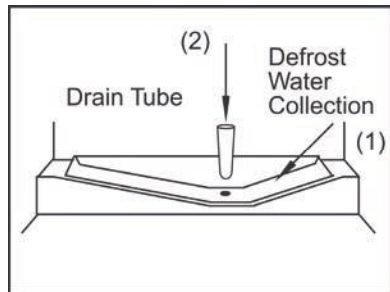

During defrosting water droplets may form at the back of the fridge compartment where the concealed evaporator is located. Some droplets may remain on the liner and refreeze when defrosting is completed. **Do not use pointed or sharp edged objects such as knives or forks to remove the droplets which have frozen.**

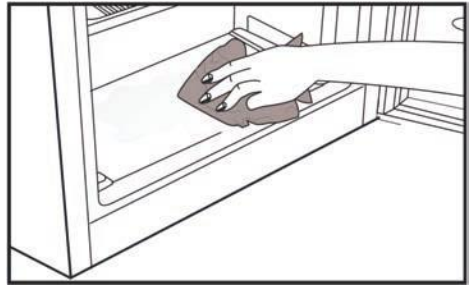
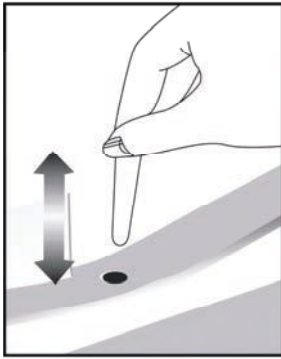

Insert the plug in to the wall socket and switch on the electricity supply.

If at any time the defrost water does not drain from the collection channel, check to ensure that no food particles have blocked the drain tube. The drain tube can be cleared by pushing a blunt round plastic object into it (2). If the frost layer reaches about 7 mm, reduce the setting (i.e. from 4 to 1) to restart automatic defrosting.

Defrosting Freezer compartment

To start the defrosting procedure switch off the refrigerator at the wall socket and pull out the mains plug. All food should be wrapped in several layers of newspaper and stored in a cool place (e.g. fridge or larder).

Remove all freezer drawers. Containers full of warm water may be placed carefully in the freezer to speed up the defrosting process.

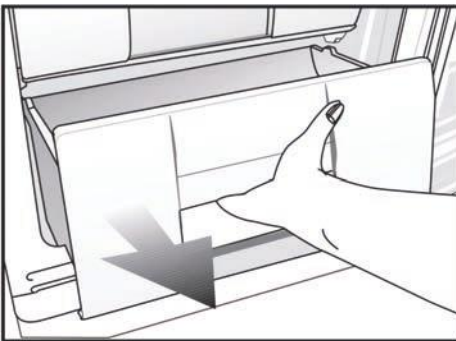

Do not use pointed or sharp edged objects such as knives or forks to remove the frost. Never use hairdryers, electrical heaters and other similar electrical appliances for defrosting. When defrosting has finished, sponge out any defrost water which collects at the bottom of the freezer and dry the interior thoroughly.

Deep-freeze information

- Food must be frozen as rapidly as possible when placed in a freezer to maintain its quality.
- It is possible to keep food for a long time period only at temperatures of -18°C or lower.
- The quality of food in a freezer can be maintained for many months at temperatures of -18°C or lower.
- Pre-packed commercially frozen food should be stored in accordance with the frozen food manufacturer's instructions for a (4 star) frozen food storage compartment.
- To ensure that the high quality achieved by the frozen food manufacturer and the food retailer is maintained, the following should be remembered: Put packages in the freezer as quickly as possible after purchase. Ensure that contents are labelled and dated. Do not exceed "Use By" or "Best Before" dates on the packaging.
If there is a power failure do not open the freezer door. Even if the power failure lasts up to the "Temperature rise time", frozen food will not be affected. In case the failure lasts longer, the food must be checked and when necessary, must be consumed immediately or must be frozen after being cooked.
- Wrap all food before storage. Seal all foods, or place in airtight containers to prevent dehydration.
- Eliminate all the air pockets from packages and keep air out by firm sealing.
- When packaging in sheet material such as aluminium foil, parcel tightly and press out all air pockets. All folds should be sealed with deep-freeze sealing tape.
- Unwrapped food containing acids or salt may permanently stain the cabinet interior.
- When loading bulk into the freezer, load one quarter at a time and allow to freeze before loading the next quarter.
- Divide food into reasonable portions according to your requirements.
- Allow hot food to cool before putting it into the freezer. Freeze cooked food in small quantities. This ensures rapid freezing and maintains the quality of the food.
- Food that has defrosted must be consumed within 24 hours. Only cooked food can be refrozen. Do not re-freeze food that has defrosted.
- Do not exceed the expiry date shown on food packs.
- Do not take out frozen food with wet hands. Your hands could stick to the frozen food.
- Always use appropriate packaging material to avoid odour penetration or degradation of the food.
- Transport pre-frozen food from the supermarket in foil lined cooler bags and transfer to the home freezer as soon as possible.

- Place fresh food to be frozen near the side walls of the freezer to ensure fast freezing.
- Never exceed the maximum freezing capacity of the freezer. If you are going to freeze fresh food in excess of 2 kg. turn the Quick Freeze function on and wait for at least three hours before placing the fresh food in the freezer. Do not freeze too large a quantity of food at any one time. The quality of the food is best preserved when it is frozen right through to the centre as quickly as possible. Take special care not to mix already frozen food and fresh food. (Depends on model)

Defrosting

The fridge and freezer compartments defrost automatically. (Depends on model).

Note If you find that the door of the freezer is difficult to open just after you have closed it, this is due to the pressure difference which will equalize and allow for the door to be opened normally after a few minutes.

Deep Freeze packaging information

Materials to be used for packaging must be tear-proof and resistant to cold, humidity, odour, oils and acids and they must also be airtight. They must be made from materials that are suitable for deep freeze usage.

Materials necessary for packaging

Cold resistant adhesive tape, Self adhesive labels, Rubber rings and a Pen.

Freezer compartment settings (C368 & C387)

Freezer compartment settings		
Freezer Compartment Setting	Fridge Compartment Setting	Explanations
-18°C	4°C	This is the normal recommended setting.
-20,-22 or -24°C	4°C	These settings are recommended when the ambient temperature exceeds 30°C.
Quick Freeze	4°C	Use when you wish to freeze your food in a short time. Your refrigerator will return to its previous mode when the process is over.
-18°C or colder	2°C	If you think that your fridge compartment is not cold enough because of the hot conditions or frequent opening and closing of the door.
-18°C or colder	Quick Fridge	You can use it when your fridge compartment is overloaded or if you wish to cool down your food rapidly. It is recommended that you activate quick fridge function 4-8 hours before placing the food.

Placing the food

Placing foods (Parts depend on model)	
Freezer compartment shelves.	Various frozen food such as meat, fish, ice cream, and vegetables.
Egg holder.	Eggs.
Fridge compartment shelves.	Food in pans, covered plates and closed containers.
Fridge compartment door shelves.	Small and packaged food or drinks (such as milk and fruit juice). Delicatessen products (cheese and butter).
Crisper.	Vegetables and fruits.

6 Water Dispenser

(Depends on model)

The water dispenser is a very useful feature with regards to accessing chilled water without having to open the door of your fridge. Since you do not have to open the door of your fridge frequently, you also save on electricity.

Using the water dispenser

Push in the lever of the water dispenser with your glass for water flow. Releasing the lever cuts off the water flow. When operating the water dispenser, maximum flow is achieved by fully depressing the lever. Please note, how much water flows from the dispenser depends on how far you depress the lever. As the level of water in your cup / glass rises, gently reduce the amount of pressure on the lever to avoid overflow. If you depress the lever by a small amount, then the water will only trickle; this is perfectly normal and is not a fault.

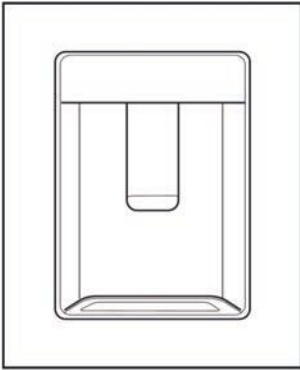

Filling the water dispenser's tank

The water tank filling reservoir is located inside the door rack. Open the reservoir cover and fill up with pure and clean drinking water. Close the cover.

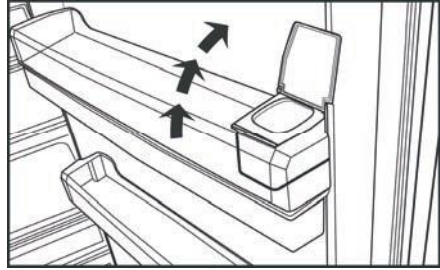
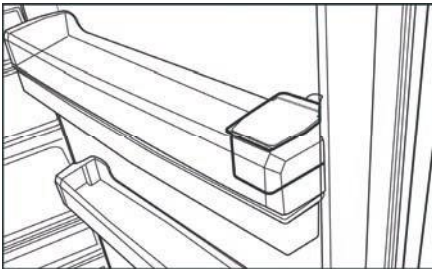

Warning!

Do not fill the water tank with any liquid other than drinking water; beverages such as fruit juice, carbonated beverages and alcoholic drinks are not suitable for use with the water dispenser. If such liquids are used, the water dispenser will malfunction and may be damaged beyond repair. The warranty does not cover such usage. Some of the ingredients and additives in these drinks / beverages may also attack and damage the water tank material.

Use clean and pure drinking water only.

Capacity of the water tank is 2.0 litres; **do not overfill**. Push the arm of the water dispenser with a rigid glass. If you are using disposable plastic glasses, push the arm with your fingers from behind the glass.

Cleaning the water tank

- Remove the water filling reservoir inside the door rack.

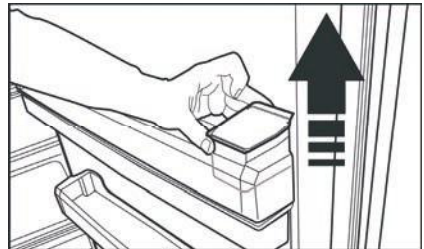

- Remove the water dispenser shelf by holding from both sides.

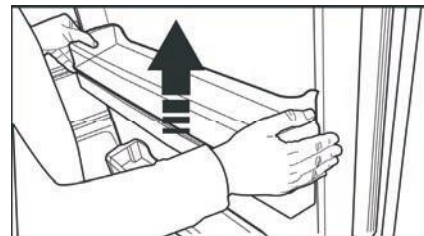

- Grab the water dispenser reservoir on both sides & remove it at an angle of 45°.

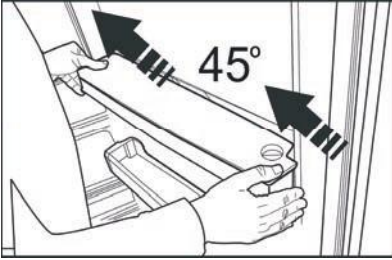

- Clean the reservoir by removing its lid.

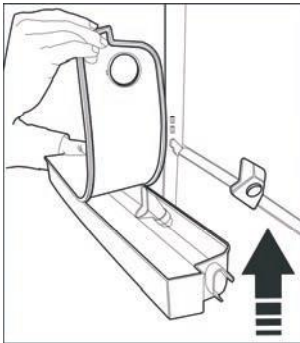

Make sure that the parts and seals removed (if any) as illustrated in the exploded diagram below, during cleaning are properly refitted to prevent any water leakage.

WATER FILLING RESERVOIR

WATER DISPENSER SHELF

WATER DISPENSER LID

WATER DISPENSER INNER SILICONE SEAL

WATER DISPENSER RESERVOIR

WATER DISPENSER OUTER SILICONE SEAL

SPRING

NOZZLE

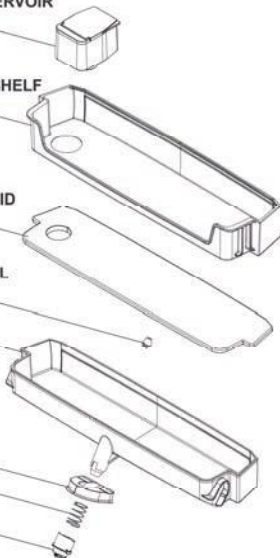

	WARNING: Do not wash any of the water tank parts in a dishwashing machine.
--	--

Water tray

Any water that drips whilst using the water dispenser accumulates in the spillage tray.

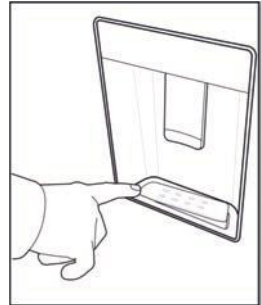

Remove the plastic strainer by pressing on the side as shown in the figure. With a clean and dry cloth, remove the water that has accumulated.

Icematic and Ice storage container

***optional** (Depends on model)

Using the Icematic

Fill the Icematic with water and place it into its seat. Your ice will be ready in approximately two hours. Do not remove the Icematic from its seating to take ice.

Turn the knobs on the ice reservoirs clockwise by 90 degrees. Ice cubes in the reservoirs will fall down into the ice storage container below. You may take out the ice storage container and serve the ice cubes. If you wish, you may keep the ice cubes in the ice storage container.

Ice storage container

The ice storage container is only intended for accumulating ice cubes. Do not put water in it as this will cause it to break.

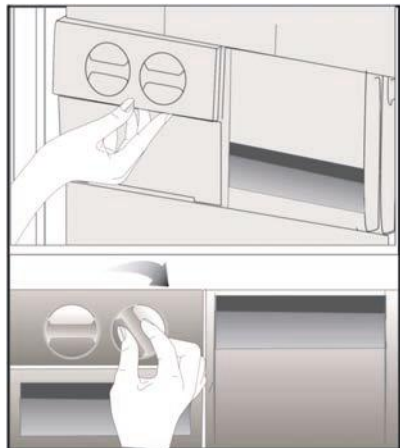

7 Maintenance and Cleaning

- Always disconnect the plug from the mains socket before cleaning.
- Note that turning the thermostat to '0' does not switch the power off to the refrigerator.
- Clean the inside of the refrigerator when necessary by using a solution of one table spoon of Bicarbonate of Soda to two litres of warm water.
- Dry with a soft cloth.
- Do not use pot scrapers or abrasive powders to clean the refrigerator.
- Spillages, especially citric and acidic juices, must be wiped up immediately as they could stain the interior of the refrigerator.
- Shelves and freezer baskets, where fitted, may be removed for cleaning purposes.
- The back of the refrigerator may be vacuumed or dusted using a soft bristle brush.
- A mild furniture polish may be used on the exterior cabinet to add lustre and protect against finger marks.
- Make sure that no water enters the lamp housing and other electrical items.
- If your refrigerator is not going to be used for a long period of time, unplug the power cable, remove all food, clean it and leave the door ajar.
- Check door seals regularly to ensure they are clean and free from food particles.
- To remove door racks, remove all the contents and then simply push the door rack upwards from the base.



Important: Remove the bottom door shelf in order to remove the crisper.

Protection of plastic surfaces

Do not place liquid oils or oil-cooked meals in your refrigerator in unsealed containers as they may damage the plastic surfaces. In case of spilling or smearing oil on the plastic surfaces, clean and rinse the relevant part of the surface at once with warm water.



Warning: Repairs must be carried out by authorised persons only. Repairs carried out by incompetent persons create a user risk.



Unplug the refrigerator from the wall socket when you clean the refrigerator.

Replacing the illumination lamp

(C366, C367, C385, C386 models only)

1. Switch off at the wall socket and pull out the mains plug.
- Shelves may be removed for easy access.
2. Use a flat tipped screwdriver to remove the light diffuser cover by inserting the blade into each of the two recesses to prise off each side.
3. First check that the bulb is not loose by ensuring it is securely screwed into the holder. Refit the plug and switch on. If the bulb works, replace the light cover by inserting the rear lug and pushing up to locate the front two lugs.
4. If the light still fails to work, switch off at the wall socket and pull out the mains plug. Replace the bulb with a new 15 watt (max) screw cap (SES) bulb.
5. Carefully dispose of the burnt-out light bulb. A replacement light bulb can be obtained from a good local electrical or DIY store.

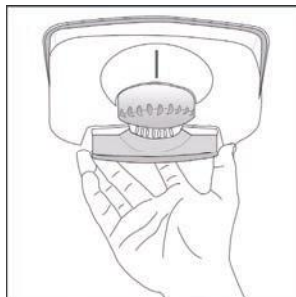
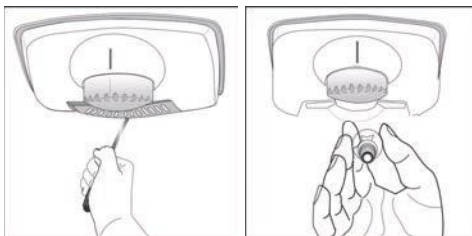

Replacing the illumination lamp

(C368, C387)

To change the lamp used for illumination of your refrigerator, please call your Authorized Service.

8 Troubleshooting

Please review this list before calling a service centre. It could save you time and money. This list includes frequent complaints that do not arise from defective workmanship or material usage. Some of the features described here may not apply to your model.

Symptom	Check
The refrigerator does not operate.	<ul style="list-style-type: none"> • Make sure the refrigerator plug is securely plugged in. • Check for a blown fuse or tripped circuit breaker. • Test the wall socket for power using another appliance. • Inspect the electrical cord for damage. • Eliminate the use of an extension cord, if any is being used.
Condensation on the side wall of the fridge compartment.	<ul style="list-style-type: none"> • Very cold ambient conditions. Frequent opening and closing of the door. Highly humid ambient conditions. Storage of food containing liquid in open containers. Leaving the door ajar. Switching the thermostat to a colder degree. • Decreasing the amount of time the door is left open or using it less frequently. • Covering the food stored in open containers with a suitable material. • Wipe the condensation using a dry cloth and check if it persists.
Compressor is not running.	<ul style="list-style-type: none"> • The protective thermal relay of the compressor will blow out during sudden power failures or plug-outs and plug-ins as the refrigerant pressure in the cooling system of the refrigerator has not yet been balanced. Your refrigerator will start running approximately after 15 minutes. Please call a service centre if the refrigerator does not start up at the end of this period. • The refrigerator is in defrost cycle. This is normal for an automatic defrosting refrigerator. The defrosting cycle occurs periodically. • Your refrigerator is not plugged into the wall socket. Make sure that the plug is properly fitted into the wall socket. • Have the temperature adjustments been correctly made? • Power might be cut off.
Condensation on the inner walls of refrigerator.	<ul style="list-style-type: none"> • Hot and humid weather increases icing and condensation. It is normal and not a fault. • Doors might have been left ajar; ensure the doors are fully closed. • Doors might have been opened frequently or left ajar for a long time; open them less frequently.
Food kept in the fridge compartment drawers are freezing.	<ul style="list-style-type: none"> • The fridge temperature might have been adjusted to a very low temperature. Adjust the fridge temperature to a warmer degree and check.
Freezer temperature is very low while the fridge temperature is sufficient.	<ul style="list-style-type: none"> • The freezer temperature is adjusted to a very low temperature. Adjust the freezer temperature to a warmer degree and check.
Fridge temperature is very low while the freezer temperature is sufficient.	<ul style="list-style-type: none"> • The fridge temperature might have been adjusted to a very low temperature. Adjust the fridge temperature to a warmer degree and check.
Temperature in the fridge or freezer is very high.	<ul style="list-style-type: none"> • The fridge temperature might have been adjusted to a very high degree. Fridge adjustment has an effect on the temperature of the freezer. Change the temperature of the fridge or freezer until the fridge or freezer temperature reaches a sufficient level. • Doors might have been opened frequently or left ajar for a long time; open them less frequently. • Door might have been left ajar; close the door completely. • Large amount of hot food might have been put in the refrigerator recently. Wait until the fridge or freezer reaches the desired temperature. • The refrigerator might have been plugged in recently. Complete cooling down of the refrigerator takes time.

Symptom	Check
The fridge is running continuously or for a long time.	<ul style="list-style-type: none"> Your new refrigerator may be wider than the previous one. This is quite normal. Large refrigerators operate for a longer period of time. The ambient room temperature may be high. This is quite normal. The refrigerator might have been plugged in recently or might have been loaded with food. Cooling down of the refrigerator completely may last for a couple of hours longer. Large amounts of hot food might have been put in the refrigerator recently. Hot food causes longer running of the refrigerator until the food has cooled down. Doors might have been opened frequently or left ajar for a long time. The warm air that has entered into the refrigerator causes the refrigerator to run for longer periods. Open the doors less frequently. The freezer or fridge compartment door might have been left ajar. Check that the doors are tightly closed. The refrigerator is adjusted to a very low temperature. Adjust the refrigerator temperature to a warmer degree and wait until the temperature is achieved. The door seal of the fridge or freezer may be soiled, worn out, broken or not properly seated. Clean or replace the seal. A damaged/broken seal causes the refrigerator to run for a longer period of time in order to maintain the current temperature.
Humidity occurs on the outside of the refrigerator or between the doors.	<ul style="list-style-type: none"> There might be humidity in the air; this is quite normal in humid weather. When the humidity is less, condensation will disappear.
Bad odour inside the refrigerator.	<ul style="list-style-type: none"> The inside of the refrigerator must be cleaned. Clean the inside of the refrigerator with a sponge, lukewarm water or carbonated water. Some containers or package materials might cause the smell. Use a different container or different brand of packaging material.
Crispers are stuck.	<ul style="list-style-type: none"> The food might be touching the ceiling of the drawer. Rearrange the food in the drawer.
The door is not closing.	<ul style="list-style-type: none"> Food packages may prevent the door's closing. Repack the packages that are obstructing the door. The refrigerator is not completely level on the floor and rocks when slightly moved. Adjust the elevation screws. The floor is not level or strong. Make sure that the floor is level and capable of carrying the weight of the refrigerator.
Noise like wind blowing.	<ul style="list-style-type: none"> Fans are used to cool the refrigerator. It is normal and not a fault.

	<p>Warning: Repairs must be carried out by authorised persons only. Repairs carried out by incompetent persons create a user risk.</p>
--	---

	<p>DANGER! Always disconnect the plug from the wall socket before any maintenance or cleaning.</p>
---	---

Owner's responsibility

Do not damage the refrigerant circuit.

Do not use electrical appliances inside the food storage compartments of the appliance, unless they have been recommended by the manufacturer.

Since the following are not factory faults they are the owners responsibility:

- Damage to the exterior finish.
- Breakage of glass and other components.
- Replacement of light bulbs.
- Damage caused through improper use of the appliance.
- Damage caused by moving the appliance.

9 Refrigerator specifications

Full no frost models

MODEL	C387	C368
APPLIANCE TYPE	FRIDGE	FRIDGE
Net volume (l)	327	302
Dimensions (HxWxD) mm	1845 x 600 x 650	1745 x 600 x 650
Energy efficiency class (1)	A+	A+
Climate class	SN-T	SN-T
Refrigerant	R600a	R600a
(1) Energy classes : A+++ . . . G (A+++ = economical . . . G = less economical)		

Semi no frost models

MODEL	C386
APPLIANCE TYPE	FRIDGE
Net volume (l)	334
Dimensions (HxWxD) mm	1845 x 600 x 650
Energy efficiency class (1)	A
Climate class	SN
Refrigerant	R600a
(1) Energy classes : A+++ . . . G (A+++ = economical . . . G = less economical)	

Auto defrost models

MODEL	C385	C385WD	C366	C367
APPLIANCE TYPE	FRIDGE	FRIDGE	FRIDGE	FRIDGE
Net volume (l)	350	348	325	323
Dimensions (HxWxD) mm	1845 x 600 x 650	1845 x 600 x 650	1745 x 600 x 650	1745 x 600 x 650
Energy efficiency class (1)	A	A	A	A
Climate class	SN	SN	SN	SN
Refrigerant	R600a		R600a	R600a
(1) Energy classes : A+++ . . . G (A+++ = economical . . . G = less economical)				

Branches

If you have followed the instructions and still have a problem, contact the customer care line on 086 100 3339. They will be able to advise you on any aspect of the product or send a qualified technician to repair it.

South African Branches:**BLOEMFONTEIN**

Unit Number 5
Monument Business Park
50 Monument Road
Oranjesig, Bloemfontein
Bloemfontein.Service@defy.co.za

CAPE TOWN

5A Marconi Rd. Montague Gardens, 7441
CapeTown.Service@defy.co.za

DURBAN

135 Teakwood Road, Jacobs,
Durban, 4052
Durban.Service@defy.co.za

EAST LONDON

Robbie de Lange Road, Wilsonia,
East London, 5201
EastLondon.Service@defy.co.za

GAUTENG, MIDRAND

127 15th Road, Cnr Pharmaceutical & 15th Rd,
Midrand, Gauteng
Gauteng.Service@defy.co.za

POLOKWANE

87 Nelson Mandela Drive, Superbia 0699
Polokwane.Service@defy.co.za

PORT ELIZABETH

112 Patterson Road, North End, Port Elizabeth
6001
PortElizabeth.Service@defy.co.za

Sub-Saharan Africa Branches:**ZAMBIA: SOUTHGATE INVESTMENTS LTD**

Plot 1606, Sheki Sheki Road
P.O. Box 33681
Lusaka, 10101, Zambia
Tel: +260 0211 242332/3
Fax: +260 0211 242933
sgiservicecentre@microlink.zm

NAMIBIA: ATLANTIC DISTRIBUTORS (PTY) LTD

10 Tienie Louw Street, Northern Industrial Area
P.O. Box 21158, Windhoek, Namibia
Tel: (061) 216162
Fax: (061) 216134
atlantic@mweb.com.na

ZIMBABWE: TRADECOMAFRICA

Trade Com Africa, 183 Loreley Crescent
Msasa, Harare, Zimbabwe
Tel: +263 4 486165/6
Cell: +263 772 469010
Cell: +263 772 469011

BOTSWANA: RAY MORGAN AGENCIES

RMA Service Centre, Plot 48, East Gate
Gaborone International Commerce Park
Kgale View, Gaborone
Botswana
Tel: +267 390 3996 / 390 3912
Fax: +267 318 7376
Cell: +267 7134 6539
service@rma.co.bw; raja@rma.co.bw

SWAZILAND: LYNDS DISTRIBUTORS

P.O Box 716, Mbabane, Swaziland, H100
Tel: (00268) 2515 4310/8
Fax: (00268) 2518 4318

MOZAMBIQUE: COOL WORLD. LDA

Rua da Resistencia No. 97B R/C
Cell: +258 84 44 61 234
coolworldlda@hotmail.com
Nosso Show Room
Av: da Industrias, Parcela No.735 * 735A
Machava, Maputo

Please register your product at

www.defy.co.za

DEFY APPLIANCES (PTY) LTD
P.O.BOX 12004
JACOBS
DURBAN
4026
SOUTH AFRICA

This certificate is issued by DEFY APPLIANCES LIMITED manufacturers of Defy and Ocean products, hereinafter the Company, to the original purchaser only, of the appliance described on the certificate and shall constitute the only warranty given in respect of this appliance.

The Company warrants to the original purchaser that for a period of *THREE YEARS from date of purchase, plus an additional *TWO years on registration, the appliance is free from defect under normal domestic use, both in workmanship and material, subject to the following conditions.

1. Repair or replacement of any part of this appliance, found by the Company to be defective, shall be at the election of the Company. The Company reserves the right to effect such service through any of its Service Divisions or Authorised Service Dealers. The cost of such service shall be borne by the Company in full, provided that the appliance is located no further than 50km from a Company Service Centre or an Authorised Service Dealer. Where the appliance is located beyond the 50km radius, the purchaser shall be liable for the standard travelling charges, as determined by the Company.
2. Vitreous enamelware, fuses and lamps are specifically excluded from these warranties. It is an express condition of these warranties that the purchaser takes due care and attention in the use and maintenance of the appliance. Abuse, misuse in conflict with operating instructions, connection to incorrect voltages and subsection to commercial use shall release the Company from its obligations.
3. This warranty shall become void and cease to operate if the appliance is dismantled by, or any repairs to the appliance are effected by any persons not duly authorised by the Company, or if substitute parts not approved by the Company are used in the appliance, or if the serial number of the appliance is removed.
4. The Company shall not be responsible for damages resulting from fire, flood, civil disturbances or any Act of God. The Company shall not, in terms of these warranties be responsible nor held liable for any consequential loss or damage of any kind caused by or due to the failure or malfunction of the appliance. The Company shall not be responsible for damages caused by insect and/or animal infestation.
5. The Company shall not be responsible for transportation or other costs other than those incurred within the provisions of Point 1 of this Certificate.
6. **For warranties in the Republic of South Africa and Sub-Saharan Africa, please contact the customer care line. Please refer to the previous page for respective South African branches and Sub-Saharan Africa branches.**
7. Where service is requested under warranty and no fault or defect can be found by the Company, all costs incurred will be for the purchaser's account.
8. This Certificate as well as your invoice will serve as proof of purchase. For the purpose of warranty, it will be essential to produce this Certificate and invoice. Failure to do so, will render the purchaser liable for service costs.

KEEP THIS CERTIFICATE AND SALES INVOICE AS PROOF OF PURCHASE FOR WARRANTY PURPOSES.

*THREE YEARS full coverage, additional *TWO YEARS (with registration) will cover only parts, labour cost to be charged accordingly. Please register your product at www.defy.co.za in order to activate the additional two year warranty.